



BJ bronces jordá



CATÁLOGO
GENERAL





C/ Oliva, nº 10 - 46710 DAIMUZ (Valencia) - España

Teléfono: 96 281 93 93 - Fax: 96 281 96 05

e-mail: | ventas@bronces-jorda.com
| bronces-jorda@bronces-jorda.com
www.bronces-jorda.com

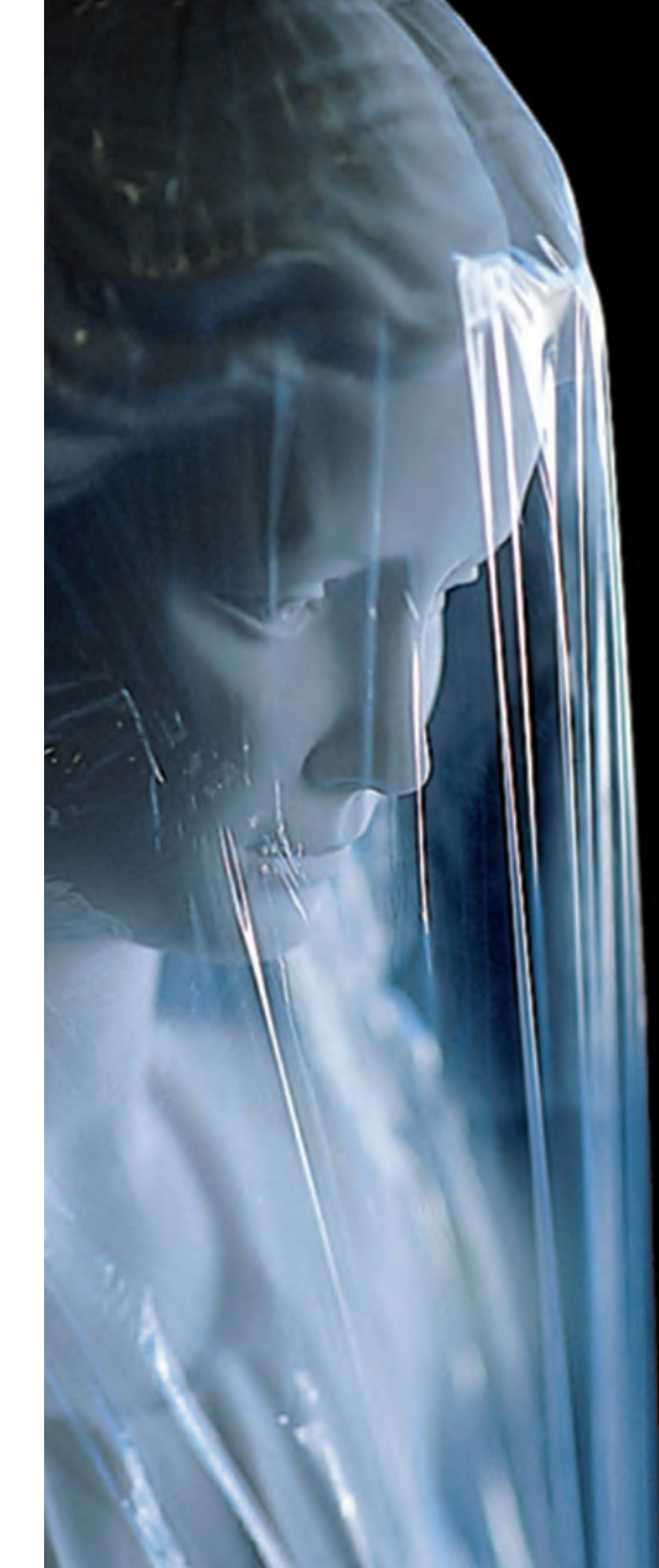

desde 1939
sentimos
nuestro **trabajo**
de principio a fin

*since 1939 we feel our **work**
from the begining till the end*

vocación y experiencia

*vocation and
experience*

El fundador de Bronces Jordá era un artesano que con sus propias manos cincelaba, modelaba y fundía piezas únicas en bronce. En 1939 creó Bronces Jordá, una empresa familiar dedicada a la fabricación de artículos funerarios para testimoniar el respeto y recuerdo hacia nuestros familiares más queridos.

Hoy, 71 años después, la tercera generación de la familia Jordá ha conseguido que la empresa integre la artesanía heredada con las nuevas tecnologías. De este modo la expansión internacional de la empresa es una realidad y los productos llegan a más de 39 países. Esto se ha alcanzado siguiendo el camino trazado por su fundador: el de la calidad.

Bronces Jordá es un grupo industrial líder en el sector de la fundición especializada en arte funerario, capaz de controlar todo el proceso de producción de sus artículos desde la idea hasta su acabado y comercialización. Con esta filosofía hemos confeccionado un amplio catálogo de imágenes, esculturas y elementos decorativos donde usted encontrará aquello que desee.

Bronces Jordá was founded by a craftsman that carved, molded and cast unique pieces in bronze. In 1939, he created Bronces Jordá, a family-run company dedicated to the manufacture of funerary articles designed to bear witness the respect and the memory of our most beloved.

Today, 71 years later, the third generation of the Jordá family has obtained the full integration of the traditional craft techniques inherited from the firm's founder with the very high technology. This achievement has the international expansion becoming a reality, with the firm's products being distributed in more than 39 countries. This has been possible by following the path traced by the firm's founder: the path that leads to quality.

Bronces Jordá is a leading industrial group within the specialized funerary-art casting sector, capable of controlling the entire production process of its articles, from the initial idea to the finishing and commercialization processes. With this philosophy, we have produced an extensive catalogue of images, sculptures and decorative elements in which the reader is sure to find what is looking for.

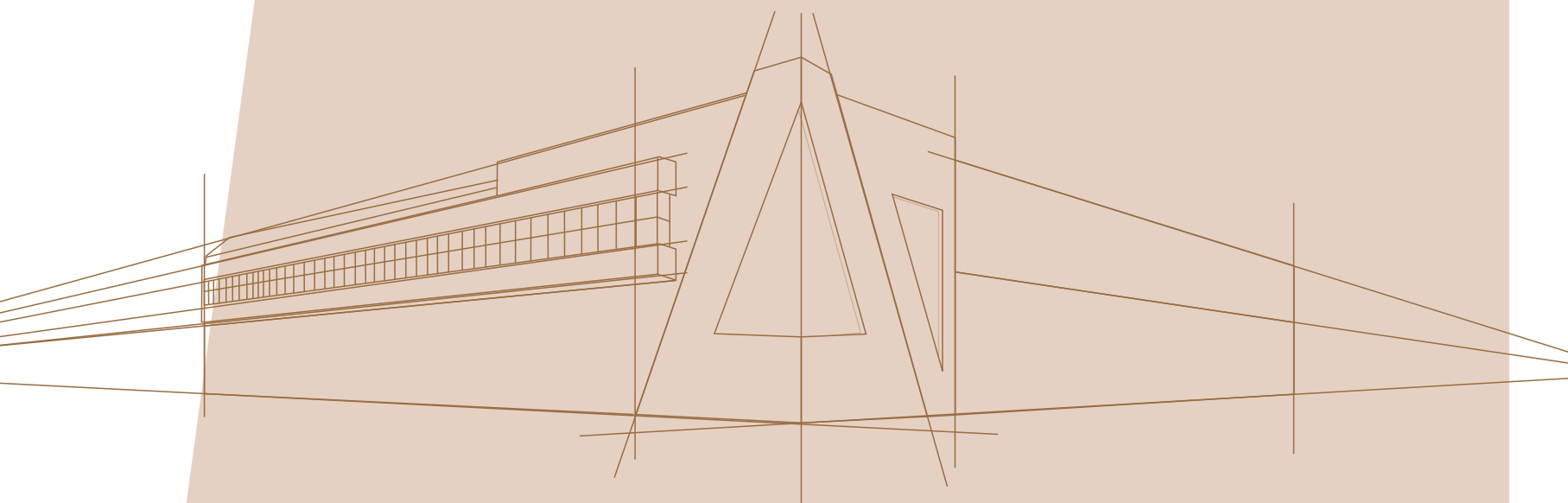

O fundador da Bronces Jordá era um artesão que, com as suas próprias mãos, cinzelava, modelava e fundia peças únicas em bronze. Em 1939 criou a Bronces Jordá, uma empresa familiar dedicada à fabricação de artigos funerários para testemunhar a memória e o respeito aos nossos familiares mais queridos.

Hoje, 71 anos depois, a terceira geração da família Jordá conseguiu fazer com que a empresa integre o artesanato herdado com as novas tecnologias. Deste modo, a expansão internacional da empresa é uma realidade e os produtos chegam a mais de 39 países. Isto alcançou-se seguindo o caminho esboçado pelo seu fundador: o da qualidade.

A Bronces Jordá é um grupo industrial líder no sector da fundição especializada em arte funerária, capaz de controlar todo o processo de produção dos seus artigos desde a ideia até o seu acabamento e comercialização. Com esta filosofia elaboramos um amplo catálogo de imagens, esculturas e elementos decorativos no qual você encontrará aquilo que deseja.

Le fondateur de Bronces Jordá était un artisan qui, de ses propres mains, ciselait, modelait et fondait des pièces uniques en bronze. En 1939, il créa Bronces Jordá, une entreprise familiale dédiée à la fabrication d'articles funéraires permettant de se souvenir et de témoigner du respect aux êtres qui nous sont les plus chers.

Aujourd'hui, 71 ans plus tard, la troisième génération de la famille Jordá est parvenue à ce que l'entreprise combine cet héritage artisanal avec les nouvelles technologies. C'est ainsi que l'expansion internationale de l'entreprise est devenue réalité: les produits sont expédiés dans plus de 39 pays. Ceci a pu être obtenu en suivant la voie tracée par son fondateur: celle de la qualité.

Bronces Jordá est un groupe leader du secteur de la fonte spécialisée dans l'art funéraire; l'entreprise est capable de contrôler l'ensemble du processus de production de ses articles, depuis l'idée du produit jusqu'à sa finition et sa commercialisation. En suivant cette philosophie, nous avons élaboré un abondant catalogue d'images, sculptures et objets décoratifs où vous trouverez ce dont vous désirez.

Il fondatore della ditta Bronces Jordá era un artigiano che con le sue proprie mani cesellava, sformava e fondeva pezzi unici in bronzo. Nel 1939 creò Bronces Jordá, un'azienda familiare dedicata alla fabbricazione di articoli funerari col fine di testimoniare il rispetto ed il ricordo che tutti abbiamo verso i nostri cari.

Oggi, a 71 anni da allora, la terza generazione della famiglia Jordá, è riuscita a combinare quello che è l'artigianato ereditato con le nuove tecnologie. In questo modo dunque, l'espansione in campo internazionale dell'azienda è diventata realtà, ed i propri prodotti vengono venduti in più di 39 paesi. Tutto ciò è stato raggiunto seguendo la strada che il fondatore aveva tracciato: quella della qualità.

Bronces Jordá è un gruppo industriale leader nel settore delle fonderie specializzate nell'arte funeraria, in grado di controllare tutto il processo produttivo dei propri articoli, dall'idea alle rifiniture e alla commercializzazione. Seguendo questo concetto, abbiamo potuto confezionare un ampio catalogo di immagini, sculture ed elementi decorativi in cui potrete trovare tutto ciò che desiderate.

De oprichter van Bronces Jordá was een ambachtsman die eigenhandig unieke modellen beitelde, modelleerde en in brons goot. In 1939 richtte hij Bronces Jordá op, een familiebedrijf dat zich toelegde op de het maken van grafdecoraties, bronzen creaties die herinnerden en respect betoonden aan zij die heen waren gegaan.

Vandaag de dag, 71 jaar later, is de derde generatie van de familia Jordá erin geslaagd de traditie van het ambachtswerk en de toepassing van nieuwe technologieën perfect te integreren. Zo is de internationale expansie van het bedrijf een realiteit en onze producten zijn te vinden in meer dan 39 landen. Dit hebben we bereikt door het kwaliteitsaspect al die jaren hoog in ons vaandel te houden.

Bronces Jordá is een leidinggevend bedrijf in de gespecialiseerde graf-decoraties gieterij dat in staat is om het gehele productieproces van haar artikelen te controleren, vanaf het eerste ontwerp tot en met de afwerking en de vermarkting ervan. Trouw aan deze filosofie hebben we een uitgebreide catalogus samengesteld vol creaties, sculpturen en decoratieve elementen waarin u beslist datgene zult vinden wat u zoekt.

70 años

70 años de trabajo especializado nos avalan

*70 years of specialized work
are the best guarantee*

4





PRESENCIA INTERNACIONAL

Los productos de Bronces Jordá están presentes en más de 39 países.

INTERNATIONAL PRESENCE

Bronces Jordá's products are present in more than 39 countries.

PRESENÇA INTERNACIONAL

Os produtos da Bronces Jordá estão presentes em mais de 39 países.

PRÉSENCE INTERNATIONALE

Les produits de Bronces Jordá sont présents dans plus de 39 pays.

PRESENZA INTERNAZIONALE

I prodotti della Bronces Jordá sono presenti in più di 39 paesi.

INTERNATIONALE VERTEGENWOORDIGING

De producten van Bronces Jordá zijn te vinden in meer dan 39 landen.

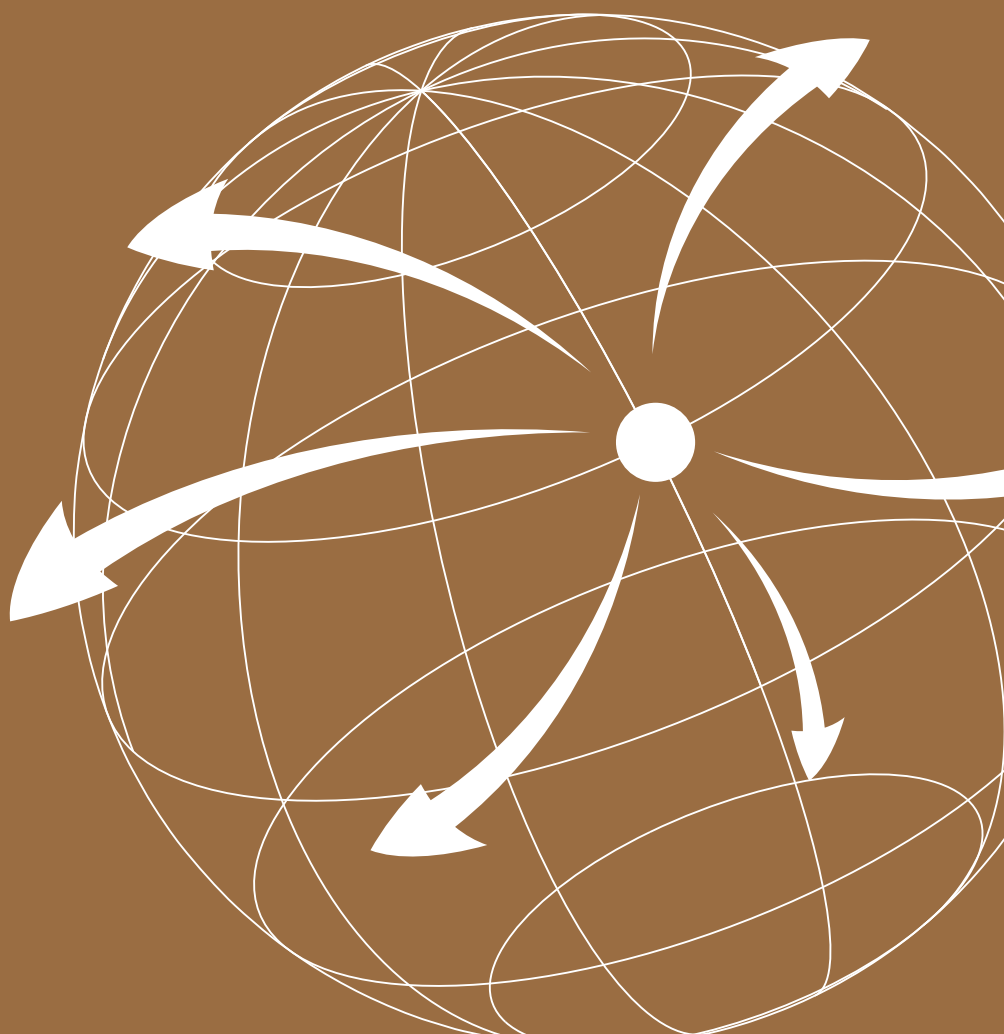

nuestra empresa

our company

Foundation Year
1939

Employees
65

Area With Buildings
19 649m²

Electric Power
1 870kw

Fundação Ano
1939

Empregados
65

Superfície Edificada
19 649 m²

Potencia Electrica
1 870 kw

Fondation Annee
1939

Employes
65

Superficie Edifie
19 649m²

Potence Electrique
1 870kw

Anno Fondazione
1939

Dipendenti
65

Superficie Edificata
19 649m²

Potenza Elettrica
1 870kw

Strichtingsjaar
1939

Werknemers
65

Bebouwde Oppervlakte
19 649m²

Electrisch Vermogen
1 870kw

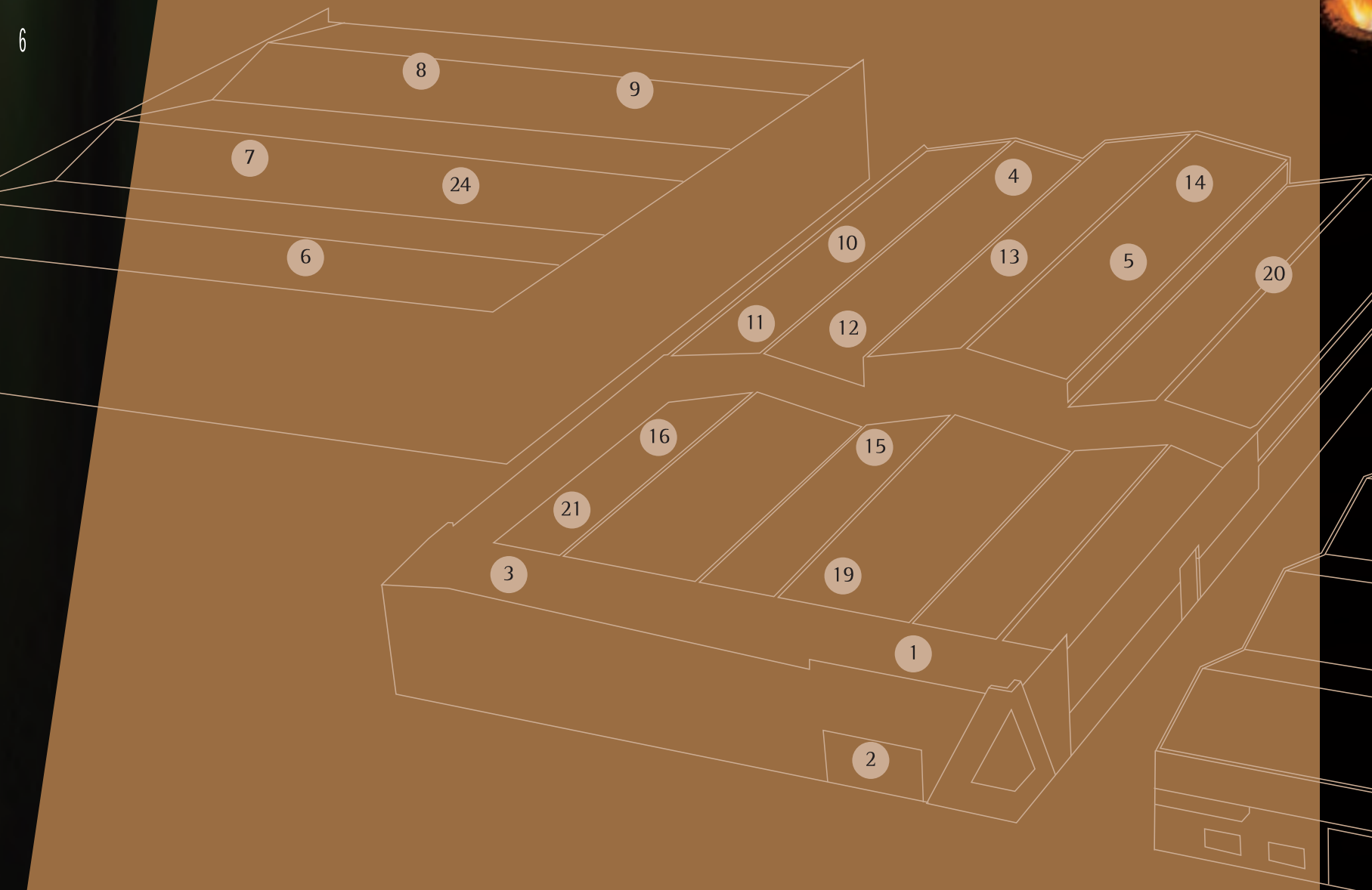



Fundación Año
1939

Empleados
65

Superficie Edificada
19 649 m²

Potencia Eléctrica
1 870 kw



1. Dirección, Administración
Managing Direction and Administration Department
2. Departamento Comercial
Commercial Department
3. Diseño y Escultura
Design and Sculpture
4. Oficina Técnica Proyectos CAD, CAM, CAE
Technical Department Projects CAD, CAM, CAE
5. Fabricación Moldes y Matrices
Die Casting and Moulds Manufacture
6. Almacen Materias Primas
Storage of Raw Materials
7. Inyección de Metales
Metals Injection
8. Fundición de Cera
Lost Wax Foundry
9. Fundición en Tierra
Sand Cast Foundry
10. Estampación en Acero Inoxidable
Stainless Steel Engraving
11. Inyección de Plásticos
Plastics Injection
12. División de Soldaduras
Welding Division
13. División Cincelado Metal
Metal Carving Division
14. División Tornos y Decoletaje
Winding Production Division
15. División Pulidos y Acabados
Polish and Finishing Division
16. Verificación Final Producto Acabado y Barnizado
Product Check Control and Varnising
17. Centro Integración Laboral Discapacitados
Handicapped Labour Integration Center
18. Almacén General Productos Acabados
General Storage of Final Products
19. Empaquetado y Distribución
Packing and Distribution
20. Fabricación Esculturas Mármol Reconstituido
Production of Sculptures in Reconstituted Marble
21. Muelles Carga y Expediciones
Loading Platform and Expeditions
22. Almacen Producto Semielaborado
General Storage of Half Finished Products
23. Departamento Grabación
Engraving Department
24. Centro de Corte por Agua a Presión
Waterjet Cutting System

amplio stock
de producto
large product stock



bronces jordá

C/ Palanca, 10
46100 Sagunto (Valencia - España)
Tel. 962.819.393 - Fax. 962.819.605
www.bronces-jorda.com

bronces jordá

C/ Oliva, 10
46100 Sagunto (Valencia - España)
Tel. 962.819.393 - Fax. 962.819.605
www.bronces-jorda.com

Bi

servicio inmediato

immediate service

A SU SERVICIO

En Bronces Jordá sabemos que usted no puede esperar. Para ello contamos con un amplio stock de todos nuestros artículos de forma que los pedidos son atendidos inmediatamente, preparados y expedidos en tan sólo 24 horas.

AT YOUR SERVICE

At Bronces Jordá, we know that you are not in a position to wait. For this reason, we maintain a large stock of all of our products in order that all our customer orders may be attended immediately, prepared and dispatched within just 24 hours.

AO SEU DISPOR

A Bronces Jordá sabe que você não pode esperar. Por isso contamos com um amplo estoque de todos os nossos artigos, de modo que os pedidos são atendidos de forma imediata e podem ser preparados e expedidos em apenas 24 horas.

A VOTRE SERVICE

Chez Bronces Jordá nous savons que vous ne pouvez attendre. Pour cette raison, nous disposons d'un large stock de chacun de nos articles de façon à ce que les commandes soient prises en compte immédiatement et puissent être préparées et expédiées en seulement 24 heures.

A VOSTRO COMPLETO SERVIZIO

Da Bronces Jordá sappiamo che voi non potete aspettare. È per questo che mettiamo a vostra disposizione uno stock di tutti i nostri articoli, di modo che, gli ordini sono soddisfatti con immediatezza e possono essere preparati e spediti in sole 24 ore.

TOT UW DIENST

Bij Bronces Jordá weten we dat niemand van wachten houdt. Daarom beschikken wij over een ruime voorraad van al onze artikelen zodat uw bestellingen meteen in behandeling kunnen worden genomen en in minder dan 24 uur gereed gemaakt en verzonden kunnen worden.



uso práctico del catálogo

Para que este catálogo resulte de fácil manejo y permita la rápida localización e identificación de un determinado artículo, hemos procedido a agruparlos en primer lugar por la materia en la que están contruidos y posteriormente, según modelos, por sus más diferenciadas características de forma y utilidad.

ATENCIÓN: Las medidas, expresadas en milímetros, centímetros o metros, deben siempre interpretarse a la vista del artículo. En algunos casos, para evitar errores, las medidas se acompañan con símbolos aclaratorios.

ENG

How to use the catalogue

To make this catalogue easy to use and allow the articles required to be quickly located we have grouped them firstly by the material they are made of and then, according to models, by their most important features in terms of shape and use.

1 cm = 0,3937 inch
1 cm = 0,0328 foot

NOTE: Measurements are expressed in millimetres, centimetres or metres, but should be interpreted by referring to the real articles. To avoid errors in some cases measurements are accompanied by explicative symbols.

PT

Uso práctico do catálogo

Para que este catálogo seja de fácil consulta e permita uma localização e identificação rápida de um determinado artigo, procedemos ao seu agrupamento em primeiro lugar tendo em conta a matéria prima de que são constituídos e em segundo lugar conforme os modelos e suas características de acordo com a sua forma e utilidade.

ATENÇÃO: As medidas expressas em milímetros, centímetros ou metros, devem ser sempre interpretadas de acordo com o artigo. Em alguns casos, para evitar erros, as medidas são acompanhadas de símbolos esclarecedores.

F

Usage pratique du catalogue

Pour que le catalogue résulte facile d'emploi et permette une rapide localisation et identification d'un article déterminé, nous procédons à grouper en premier lieu par la matière première dans lequel sont construits et postérieurement selon le modèle, pour ses caractéristiques de forme et utilité.

ATTENTION: Les mesures, exprimées en millimètres, centimètres ou mètres doivent toujours être interprété à la vue de l'article. Dans certains cas, pour éviter des erreurs, les mesures seront accompagnées avec des symboles explicatifs.

I

Uso pratico del catalogo

Affinché questo catalogo risulti facile da consultare e permetta la rapida individuazione ed identificazione di un determinato articolo, abbiamo deciso di raggrupparli, in primo luogo, a seconda della materia prima con cui sono fabbricati, e in un secondo luogo, a secondo dei modelli, per le loro caratteristiche di forma ed uso.

ATTENZIONE: Le misure, espresse in millimetri, centimetri o metri, devono sempre interpretarsi alla vista dell'articolo. In qualche caso, per evitare errori, si pongono accanto alle misure dei simboli chiarificatori.

NL

Practisch gebruik van de catalogus

Om deze catalogus gemakkelijk te kunnen gebruiken, en om een bepaald artikel vlug te kunnen lokaliseren, zijn wij als volgt te werk gegaan:

-indeling volgens de gebruikte grondstof
-indeling volgens het model, en het doel of gebruik van het artikel

OPGEPAST:

-de afmetingen in mm, cm of meter moeten steeds gezien worden in functie van het welbepaald artikel
-in sommige gevallen, om mogelijke vergissingen te vermijden, hebben wij naast de afmetingen nog een symbool geplaatst.

índice

index



Índice

- 18 Bronce
- 178 Acero Inoxidable
- 222 Mármol Reconstituido
- 294 Urnas
- 304 Mascotas
- 306 Accesorios

ENG

Index

- 18 Bronze
- 178 Stainless Steel
- 222 Reconstituted Marble
- 294 Urns
- 304 Pets
- 306 Accessories

PT

Índice

- 18 Bronze
- 178 Aço Inoxidável
- 222 Mármore Sintético
- 294 Urnas
- 304 Mascotes
- 306 Acessórios

F

Indice

- 18 Bronze
- 178 Acier Inoxydable
- 222 Marbre Reconstitué
- 294 Urnes Cinéraires
- 304 Animaux de compagnie
- 306 Accessoires

I

Indice

- 18 Bronzo
- 178 Acciaio Inossidabile
- 222 Marmo Ricostruito
- 294 Urne
- 304 Animali Domestici
- 306 Accessori

NL

Aanwijzing

- 18 Brons
- 178 Roestvrij Staal
- 222 Samengestelde Marmer
- 294 Urnen
- 304 Liefelingsdieren
- 306 Toebehoorten

E

SÍMBOLOS

ENG

SYMBOLS

PT

SIMBOLOS

F

SIMBOLES

I

SIMBOLI

NL

SYMBOLEM



Ángeles

Angels

Anjos

Angeles

Angeli

Engelen



Anillas

Rings

Asas para jazigo

Anneaux

Anelli

Ringen



Aros Foto-Cerámica

Ceramic Photo Frames

Cercaduras para fotocerámica

Cercle Photo-Ceramique

Cornici foto in Ceramica

Keramische Foto-Kader



Barandillas

Railings

Resguardos

Balustrade

Ringhiere

Afsluiting



Bases y Capiteles

Bases and Capitals

Bases e Capiteis

Base et Chapiteau

Basi e Capitelli

Basis en Kroonwerken



Bisagras y Cerraduras

Hinges and Locks

Dobradiças e fechaduras

Charnieres et Serrures

Cardini e Serrature

Scharnieren en Sloten



Búcaros

Vases

Jarras

Cruches et Vases

Vaso

Kruiken en Vazen



Bustos y Rostros de Cristo

Faces and Bust of Christ

Bostos e Rostros de Cristo

Bustes et Visages du Christ

Busti e Volti di Cristo

Bustes en Hoofden van Christus



Bustos y Rostros de Virgen

Faces and Bust of the Virgin Mary

Bostos e Rostros de Virgens

Bustes et Visages de la Vierge

Busti e Volti della Vergine

Bustes en Hoofden van Maria



Cadenas

Chains

Correntes

Chaîne

Catene

Kettingen



Columnas

Columns

Colunas

Colonnes

Colonne

Kolommen



Corazón de Jesús

Sacred Heart

Sagrado Coração de Jesús

Coeur de Jesus

Cuori di Gesù

H. Hart van Jesus



Corazón de Maria

Immaculate Heart of Mary

Sagrado Coração de Maria

Coeur de Marie

Cuori di Maria

H. Hart van Maria



Cristos

Christ

Cristos

Christ

Cristi

Christus



Cruces

Crosses

Cruzes

Croix

Croci

Kruisen



Cruces con Cristos

Crucifix

Cruzes com Cristo

Croix avec Christ

Croci con Cristo

Kruis met Christ



Faroles y Lamparillas

Lanterns and Small Lamps

Candeeiros

Lampadaires et Lanternes

Lampioni e Lampadine

Hanglampen en Lantaarns



Flores y Ramos

Flowers and Bunches of flowers

Flores e Ramos

Fleurs et Bouquets

Fiori e Rami

Bloemen en Bloemstukken



Garras

Claws

Garras

Griffes

Ganci

Hechtranken



Grabaciones

Engravings

Gravações

Gravures

Incisioni

Graveerwerk



Jardineras

Plant Pot

Floreiras

Jardinières

Giardiniera

Bloembakken



Letras

Letters

Letras

Lettres

Lettere

Letters



Libros

Books

Livros

Libres

Libri

Boeken



Manos

Hands

Mãos

Mains

Mani

Handen



Ofrendas

Tributes

Ofrendas

Offrandes

Offerte

Offer



Palomas

Doves

Pombas

Colombes

Colombe

Duiven



Paisajes

Landscapes

Paisagens

Paysages

Paesaggi

Landschappen



Pax

Pax

Pax

Paix

Pax

Vrede Teken



Peanas

Pedestals

Peanhas

Socle

Paenas

Sokkels

Symbols

	E SÍMBOLOS	ENG SYMBOLS	PT SIMBOLOS	F SIMBOLES	I SIMBOLI	NL SYMBOLEM
	Pergaminos, Placas, INRIS	Scrolls, Plaques and INRI	Pergaminhos, Placas	Parchemins et Plaques	Pergamene, Targhe ed INRI	Perkamenten en Platen
	Piedades	Pietà images inscriptions	Piedades e INRIS	Piété	Pietà	Pieta
	Placas Fundidas con Textos o Motivos en Relieve	Cast Plaques with Raised Texts and Motifs	Placas Fundidas com Textos e ou Motivos em Relevo	Plaques Fondues avec Textes et Motifs en Relief	Targe Fuje cin i Testi e Motivi in Relievo	Gegoten Plaques Met Teksten en Motieven
	Rosetas y Pomos	Stud	Cravos e Puxadores	Rosette et Pommeaux	Rosette e Pomi	Rozetten en Knoppen
	Santos	Saints	Santos	Saints	Santi	Heiligen
	Virgenes	Virgins	Virgens	Vierges	Vergini	Madonna's
	Esculturas Varias	Different Sculptures	Esculturas Diversas	Sculpures Variées	Sculture Varie	Diverse Beeldhouwweri
	Medio	Half Ornament	Meio Corpo	Demi	In Rilievo (una parte piatta)	Half
	Corpóreo	Full ornament	Corpo Inteiro	Corporel	Completa	Lichaam
	Fijación a Pared	Fixing to wall	Fixação [a Parede	Fixation au Mur	Fissaggio alla Parete	Muurbevestiging
	Fijación a Tierra	Fixing to Ground	Fixação ao Solo	Fixation par Terre	Fissaggio a Terra	Grond - Bevestiging
	Largo	Length	Largura	Large	Lungo	Breed
	Alto	Height	Altura	Haute	Alto	Hoog
	Profundidad o Relieve	Depth or Relief	Profundidade ou Relêvo	Profondeur ou Relief	Profondità o Rilievo	Diepte of Relief
	Izquierda	Left	Esquerda	Gauche	Sinistra	Links
	Derecha	Right	Direita	Droite	Destra	Rechts
	Giratorio	Revolving	Giratório	Giratoire	Girevole	Draaiend
	Base	Base	Base	Base	Base	Basis
	Depósito	Container	Depósito	Cuve (Entrepôt)	Recipiente Interno	Bekken
	Rejilla	Grid	Rede	Grilles	Grata	Rooster
	Llama Cristal	Glass Flame	Chama de Vidro	Flames de Cristal	Fiamma di Cristall	Vlam in Kristal
	Vidrio	Glass	Vidro	Verre	Recipiente di Vetro	Glas
	Tubo Hueco	Hollow Tube	Tubo Ôco	Tube Creux	Tubo Vuoto	Holle Buis
	Barra Maciza	Solid Bar	Barra Maciça	Barre Massif	Barra Massiccia	Massieve Staaft
	Energía Solar	Solar Power	Energía Solar	Énergie Solaire	Energia Solare	Zonne Energie
	Espárrago o Tornillo de Latón	Thread Bar or Screw Made in Brass	Perno ou Parafuso de Latão	Cheville Filete ou vis en Laiton	Perno o Vite da Ottone	Vouten en Vijzen in Messing Gemaakt
	Sin (espárrago, tornillo, etc.)	Without (thread bar, screw, etc.)	Sem (perno, parafuso, etc.)	Sans (cheville filete, vis, etc.)	Senza (perno o vite, etc.)	Zonder Schroef
	Sistema Adhesivo	Adhesive System	Sistema Adesivo	Système Adhésif	Sistema Adesive	Kleef Systeem
	Tornillo Acero Inoxidable	Stainless Steel Screw	Parafuso Aço Inoxidável	Vis Acier Inoxydable	Vite Acciaio Inox	Roestvrij Staal Vijzen
	Con espacio disponible para cinta adhesiva	With available space for adhesive tape	Com espaço disponível para fita adesiva	Aves espace pour ruban adhésif	Con spazio disponibile per nastro biadesivo	Met beschikbare plaats voor een zelfkleefstrip

un valor que perdura

UN VALOR QUE PERDURA

Son unas manos artesanas las que crean los modelos destinados a su producción con la más moderna tecnología en la fundición en bronce.

Bronces Jordá garantiza la calidad de todas las piezas que salen de su fábrica. Cada una de ellas se piensa, se diseña y se fabrica para que con el paso de los años su valor sea mayor. Desde la exclusiva fundición a la cera, la fundición en tierra, la estampación o la inyección de bronce todas nuestros productos cuentan con un alto grado de dificultad técnica, un esfuerzo en su creación y un cuidadoso proceso de acabado para que a usted reciba esculturas perfectas.

UM VALOR QUE PERDURA

São as mãos artesãs que criam os modelos destinados à sua produção com a mais moderna tecnologia na fundição em bronze.

A Bronces Jordá garante a qualidade de todas as peças que saem da sua fábrica. Cada uma delas foi pensada, desenhada e fabricada para que, com o passar dos anos, o seu valor seja maior. Partindo da exclusiva fundição à cera, fundição em terra, à gravação ou injeção de bronze, todos os nossos produtos contam com um alto grau de dificuldade técnica, um esforço na sua criação e um cuidadoso processo de acabamento para que você receba esculturas perfeitas.

UN VALORE CHE PERSISTE

Sono le mani di artigiani quelle che creano i modelli destinati alla produzione mediante la più moderna tecnologia nel campo delle fonderie di bronzo.

Bronces Jordá garantisce la qualità di tutti i pezzi fabbricati nel proprio stabilimento. Ciascuno di loro viene meditato, disegnato e fabbricato affinché, con il passare degli anni, il loro valore aumenti. Sin dall'esclusiva fusione a cera, la fusione in terra, la stampatura o l'iniezione del bronzo, in tutti i nostri prodotti esiste un alto grado di difficoltà tecnica, si effettua un enorme sforzo nella fase di creazione nonché un accurato processo di rifinitura, affinché le sculture che ricevete siano perfette.

A LASTING VALUE

The hands of craftsmen are responsible for creating the models employed in our technologically advanced bronze casting production process.

Bronces Jordá guarantees the quality of all the items produced in its factory. Each product is conceived, designed and manufactured in such a way as to increase its value with the passing of the years. From the exclusive lost wax and sand casting, embossing and bronze injection, all our products are manufactured using a high degree of technical skill, enormous efforts during their creation, and careful finishing processes that enable you to receive perfect sculptures.

UNE VALEUR QUI DURE

Ce sont des mains d'artisans qui créent les modèles destinés à la fabrication et ceci grâce à la technologie la plus avancée dans le domaine de la fonte du bronze.

Bronces Jordá garantit la qualité de toutes les pièces qui sortent de son usine. Chacune d'elles est pensée, dessinée et fabriquée de façon à ce qu'elle prenne de la valeur avec le temps. Qu'il s'agisse de la surprenante fonte à la cire, de la fonte en terre, du forçage ou de l'injection de bronze, tous nos produits se révèlent être d'un fort degré de difficulté technique, et sont le résultat d'un effort de création et d'un minutieux processus de finition afin que vous receviez des sculptures parfaites.

VAN BLIJVENDE WAARDE

De ervaren handen van onze ambachtslieden creëren modellen die geproduceerd worden met behulp van de meest geavanceerde technologie in bronsgieterij.

Bronces Jordá garandeert de kwaliteit van alle producten die uit haar fabriek komen. Elk model wordt op dusdanige wijze bedacht, ontworpen en gefabriceerd dat de waarde ervan in de loop der jaren alleen maar toeneemt. Vanaf de exclusieve gieterij tot aan het wasmodel, het gieten in aarde, het bedrukken of de injectie van brons, al onze producten zijn van een hoog technisch niveau, een bijzondere creativiteit en een zorgvuldige afwerking zodat u perfecte, koopt.

bronce

bronze



ACABADOS NORMALIZADOS STANDARD FINISHES

En los artículos de bronce, el acabado "satinado" es el de uso más generalizado y es el que se muestra en la mayoría de las fotos a excepción de las expuestas como ejemplos. El suministro de artículos en cualquiera de los otros 5 acabados que les ofrecemos está supeditado a limitaciones tanto técnicas como estéticas. A excepción de las letras, la referencia de un mismo artículo con diferentes acabados suele ser la misma que la del "satinado" con una letra final que identifica su acabado.

Todo artículo identificado en este catálogo y/o en tarifa con una referencia está disponible para entrega inmediata. Consulten cuando no vean claramente referenciado un artículo en el acabado que precisan. Si en un pedido no se especifica el acabado por medio de su número de referencia y letra o por el nombre que tiene asignado entenderemos que se pide en "satinado".

Por bronce debe entenderse una aleación de metales con un contenido en cobre igual o superior al 65%. Este es el criterio utilizado en los países de la UE.

Nos artigos de bronce o acabamento "satinado" é de uso mais generalizado e é o que se apresenta na maioria das fotos, com exceção das expostas como exemplos. A fornecimento dos artigos em qualquer um dos outros 5 tipos de acabamento que lhe oferecemos esta sujeito a limitações técnicas e estéticas. Com exceção das letras, a referência de um mesmo artigo com diferentes acabamentos pode ser a mesma que a do acabamento "satinado", desde que a letra final identifique o acabamento pretendido.

Todos os artigos identificados no catálogo e/ou na tabela de preços com uma referência estão disponíveis para entrega imediata. Caso não encontre referenciado um artigo no tipo de acabamento que procura consulte-nos. Se num pedido não especificar o acabamento pretendido pela sua referência e letra ou pelo nome que tem assinalado, consideraremos o pedido em "satinado".

Por bronce entende-se uma liga de metais com uma taxa de cobre igual ou superior a 65%. Este é o critério utilizado nos países da UE.

Negli articoli di bronzo, la rifinitura "satinado" è quella di uso più generalizzato ed è quella indicata nella maggioranza delle foto, salvo quelle indicate come esempi. La forniture di articoli in c'è ne degli altre 5 rifiniture che vi offriamo, è subordinata alle limitazione sia tecniche che estetiche. Salvo le lettere, la referenza dello stesso articolo con differenti rifinitura, è solitamente la stessa che quella della rifinitura "satinado" con una lettera finale che identifica la rifinitura. Ogni articolo identificato nel catalogo e/o nel listino prezzi con una referenza, è disponibile per la consegna immediata, si prega de consultare si non vedete chiaramente la referenza di un articolo con la rifinitura di che avete bisogno. Se in un ordine non si indica sigla o lettera corrispondente ad un determinato stile/modello, consideremo che corrisponde ad un modello in satinato.

Per bronzo si deve intendere una lega di metalli con un contenuto in rame uguale o superiore al 65%. Questo criterio é utilizzato nei paesi della UE.

Most of our bronze articles are shown with a "satinado" bronze finish. This is the most popular finish in our collection. The ability to use the other 5 finish is limited by the look and the technical limitations of the particular finish process. The reference of a same article with different finish is the reference of that article in "satinado" with an identifying letter at the end. All the alphabets (bronze letters) are an exception because they have different reference numbers. Any casting that is clearly shown in the catalog or in the price list is in stock and available for immediate delivery. If you do not see a product with the finish you desire, please ask us as it could be possible to make this article with the finish you desire. Any order placed without a definite reference to a specific finish will be filled using the "satinado" bronze finish.

Bronze is a metal alloy with a copper content of at least 65%. This is the criteria used by EU countries.

Dans les articles en bronze la finition "satinado" c'est la plus utilisée que l'on montre dans la plupart des photos à l'exception de celles que sont exposées comme exemple. La livraison d'articles a n'importe qu'elles autres 5 finitions que nous vous offrons est subordonné à limitations autant techniques qu'estétiques. A l'exception des lettres, la référence d'un même article avec différentes finitions c'est la même que celle de finition "satinado" avec une lettre finale qui identifie la finition.

Tout article identifié en catalogue et/ou en tarif avec une référence est en disponibilité pour livraison immédiate, consultez quand vous ne voyez pas clairement référence un article à la finition que vous demandez. Si dans une commande on ne spécifie pas la finition par son numéro de référence el lettre ou pour le nom qu'il est assigne, nous comprenons qu'on demande en "satinado"

Par bronze on doit entendre un alliage de métal avec un contenu en cuivre égal ou supérieur au 65% ce critère est l'utilisé aux pays de la EU.

Wat de bonzen artikelen betreft, wordt de afwerking "satinado" het meest gebruikt. Deze afwerking komt vaak voor op de foto's uitgezonderd diegenen die als voorbeeld worden voorgesteld. De levering van artikelen en dit zowel voor de vijf andere afwerkingen die wij U aanbieden is ondergeschikt aan technische en esthetische beperkingen. Elk geïdentificeerd artikel in de catalogus en/of in de tarieflijst met een referentie is beschikbaar voor onmiddellijke levering. Wanneer U een artikel met een bepaalde afwerking niet terugvindt, gelieve ons dan te raadplegen. Indien men in een bestelling de afwerking niet specificeert met het kenmerknummer of-letter of naam zoals beschreven, begrijpen wij dat er "satinado" gevraagd wordt.

Het brons wordt gekenmerkt door een legering in metaal met een inhoud van 65% koper of meer. Dit critère wordt gebruikt in de EEG-landen.

Acabado
Satinado
Ref. 3005



Acabado
Oro
Ref. 3005 G



Acabado
Cromado
Ref. 3005 C



Acabado
Envejecido
Ref. 3005 E



Acabado
Pulido
Ref. 3005 S

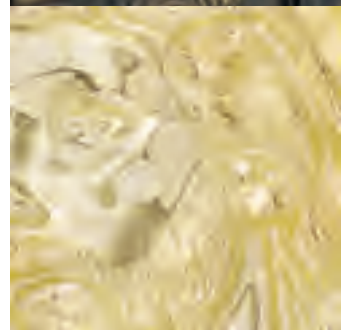

Acabado
Negro
Ref. 3005 M



ACABADOS NORMALIZADOS

STANDARD FINISHES

ejemplos

examples

NEGRO

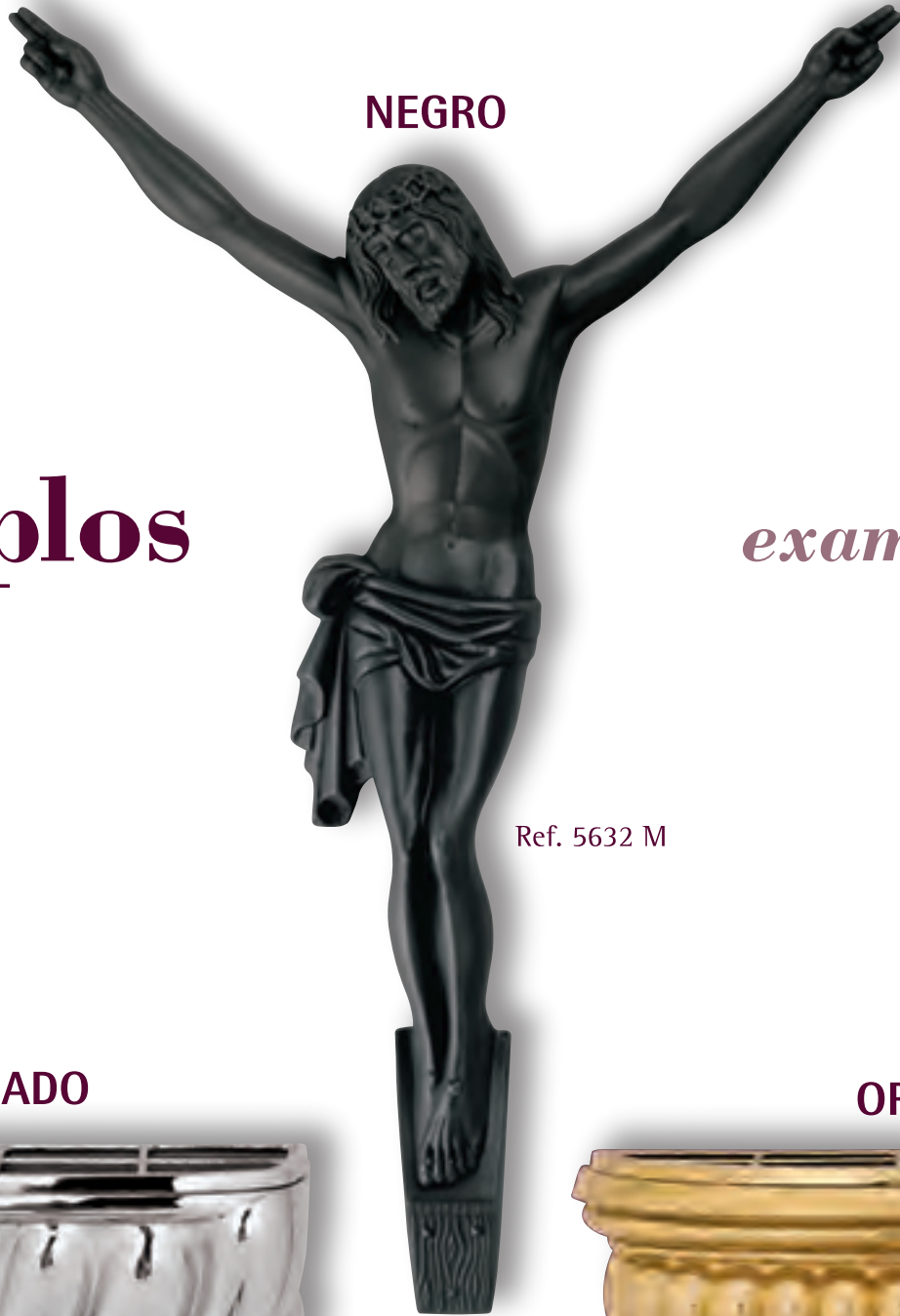

Ref. 5632 M

CROMADO



Ref. 1335 C

ORO



























Ref. 1354 G

ENVEJECIDO



Ref. 3181 E

	D 136 - 137 O 147 - 148 - 149 - 150 - 151 - 152 - 153
	O 47 - 48
	D 44 - 45 - 46
	O 46
	D 51 O 51
	D 48
	D 52 - 59 - 63 - 64 - 68 - 69 - 70 - 75 O 53 - 54 - 55 - 56 - 57 - 58 - 59 - 60 - 61 - 62 - 63 - 64 - 65 - 66 - 67 - 70 - 71 - 72 - 73 - 74 - 76
	D 119 - 120 - 121 - 125 O 170
	D 122 - 123 - 124 - 125 - 126
	O 46
	O 46
	D 115 - 116 - 125 O 168 - 169
	D 130
	D 95 - 97 - 98 - 99 - 100 - 101 - 102 - 103 - 104 - 105 - 106 - Cristo de Medinaceli 118 O 94 - 95 - 96 - 106 - Cristo de Medinaceli 167
	D 52 - 58 - 63 - 82 - 83 - 84 - 85 - 86 - 87 - 88 - 89 - 90 O 74 - 82 - 83 - 84 - 85 - 86
	D 91 - 92 - 93 O 84 - 92
	D 69 - 75 O 52 - 53 - 54 - 55 - 56 - 57 - 58 - 59 - 60 - 64 - 65 - 66 - 67 - 70 - 71 - 72 - 73 - 74 - 76 - 77 - 78 - 79 - 80 - 81
	D 141 - 142 - 143 - 144 O 138 - 139 - 140
	D 38 - 39 - 40
	D 142
	O 49 - 50
	33 - 34 - 35 - 36 - 37 - 41 - 42 - 43
	D 52 - 58 - 60 - 62 - 63 - 68 - 69 O 53 - 58 - 62 - 66 - 71 - 72 - 73 - 74
	D 19 - 20 - 21 - 22 - 23 - 24 - 25 - 26 - 27 - 28 - 29 - 30 - 31 - 32
	D 37

	O 154 - 155 - 157
	D 137 O 174 - 175
	D 142 - 143
	D 24
	D 51
	D 34 - 35 - 36
	D 107 - 108 - 109 - 110 - 111 - 112 - 113 - 114 O 146
	D 49 - 50
	S. Antonio, S. Antonio Abad 132 S. Cristóbal, S. Francisco 134 S. Joaquin, S. Jorge 133 D S. José, S. Juan 132 S. Luis 134, S. Miguel 133 S. Rafael 135 S. Ramón, S. Vicente 134
	S. Antonio 171 O S. José 172 S. Padre Pio 173 S. Patricio 172
	V. Begoña 131, V. Cabeza 127 V. Carmen 128, V. Desamparados 129 V. Dolorosa 122 V. Esperanza Macarena 131 V. Fátima 130, V. Gracia 131 D V. Inmaculada 130 V. María Auxiliadora 131 V. Montserrat 127, V. Niña 123 - 126 V. Pilar 129, V. Purísima 131 V. Rocío 131, V. Rosario 130
	Sta. Bernardette 162 V. Carmen 164 - 165 - 166 V. Dolorosa 161 O V. Fátima 160 V. Guadalupe 161 V. Inmaculada 158 - 159 V. Lourdes 162 - 163 V. Niña 158
	El Entierro 114 El Paso 117 D Nazareno 117 - 118 Oración del Huerto 135 Sagrada Familia 135 - 142
	Águilas 175 Cristo con Ángel 147 Cristo Arrodillado 167 Cristo Sentado 170 O Juan Pablo II 173 Llama 174 Mariposa 137 Nazareno 170 Resurrección 153 Virgen con niño 156

índice

JORDÁ FONT'S

Nuestro programa "Jordá Font's" facilita la composición y colocación de textos. Este sistema está disponible para abecedarios de bronce caracteres Ibérico, Alto, Relieve, Ornado, Normando y Romano desde 2 cm hasta 12 cm de alto.

Our software "Jordá Font's" makes easier to compose and place texts. This system is available for bronze alphabets characters Ibérico, Alto, Relieve, Ornado, Normando and Romano from 2 cm to 12 cm high.

Nosso programa "Jordá Font's" facilita a composição e colocação dos textos. Disponível para abecedários de bronze caracteres Ibérico, Alto, Relieve, Ornado, Normando e Romano desde 2 cm até 12 cm de alto.

Notre programme "Jordá Font's" facilite la composition et le placement de textes. En disponibilité pour alphabets en bronze caractères Ibérico, Alto, Relieve, Ornado, Normando et Romano depuis 2 cm jusqu'à 12 cm de haut.

Il nostro programma "Jordá Font's" facilita la composizione e la collocazione dei testi. Disponibile per gli alfabeti Ibérico, Alto, Relieve, Ornado, Normando e Romano e da 2 cm a 12 cm di altezza.

Onze computerprogramma "Jordá Font's" maakt het gemakkelijker om teksten samen te setten en te plaatsen. Dit systeem is beschikbaar voor de volgende bronzen alfabet karakters Ibérico, Alto, Relieve, Ornado, Normando en Romano van 2 cm tot 12 cm groot.



MEDITERRÁNEO



Ref.	↑↓ cm	• - , ~
210	2,5 * +	Ref. 210
212	4 * +	Ref. 212
214	6	Ref. 210 , Ref. 214 ~

- * Con números * With numbers * Com números
- + Con cruces y estrellas + With crosses and stars + Com cruces e estrelas

IBÉRICO



Ref.	↑↓ cm	• - ,	v
280	3,3 * +	Ref. 280	Ref. 312
281	5		Ref. 314

* Avec numéros

* Con numeri

* Met nummers

+ Avec croix et étoiles

+ Con crocette e stelle

+ Met kruisjes en sterretjes

ALTO RELIEVE



Ref.	↕ cm	• - ,
289	3 * +	Ref. 289
291	5	

ORNADO

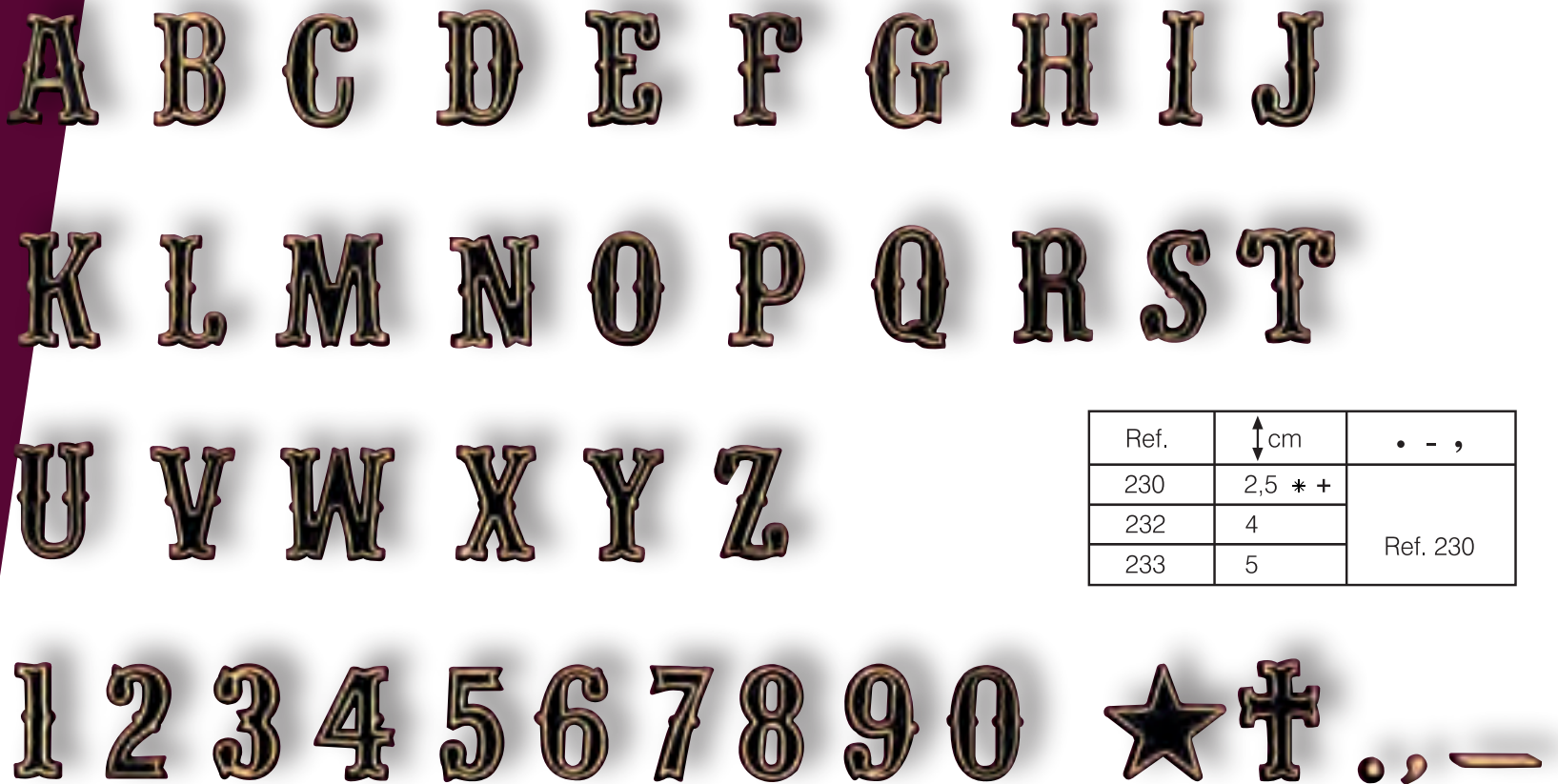

Ref.	↕ cm	• - ,
230	2,5 * +	Ref. 230
232	4	
233	5	

* Con números * With numbers * Com números
 + Con cruces y estrellas + With crosses and stars + Com cruces e estrelas

NORMANDO



Ref.	↑↓ cm	• - ,	v
215	2 * +	Ref. 216 • - 215 ,	Ref. 312
216	2,5 * +	Ref. 216	Ref.314
218	4 * +		
225	6	Ref. 216 • - 218 ,	

* Avec numéros

* Con numeri

* Met nummers

+ Avec croix et étoiles

+ Con crocette e stelle

+ Met kruisjes en sterretjes

ROMANO SATINADO



24

Ref. 309
cm 2,5



Ref.	↑ cm	• - , ~	v
△ 170	1,5 * +	Ref. 270	Ref. 308
270	2 * +		
271	2,5 * +		
272	3 * +		
273	4 * +		
274	5 *	Ref. 275 • - ,	Ref. 310
275	6		
276	8 *	Ref.277•278- ,	
278	12 *		
283	15 *	Ref. 278 • - ,	
279	20 *	Ref.279 • - , 283- ,	
286	40 *		



Ref. 780
cm 10
Ref. 784
cm 20

△ Ref. 170: letras, solo "N" y "F" - letters, only "N" and "F"

- * Con números
- * With numbers
- * Com números
- + Con cruces y estrellas
- + With crosses and stars
- + Com cruces e estrelas

CROMADO



Ref.	↑cm	• - ~
261	2,5 * +	Ref. 300 • 261-~
262	3 * +	
263	4 * +	
264	5 *	Ref. 301 • 265-
265	6	
266	8 *	Ref. 267 • 265-
268	12 *	

CUERO



Ref.	↑cm	• - , ~
250	2 * +	Ref. 250
251	2,5 * +	
252	3 * +	
253	4 * +	
254	5 *	Ref. 256 • - ,
255	6	
256	8 *	Ref. 257 • 256-

ESMERILADO



Ref.	↑cm	• - , ~
△ 167	1,5 * +	Ref. 200
200	2 * +	
201	2,5 * +	
202	3 * +	
203	4 * +	
204	5 *	Ref. 206 • - ,
205	6	
206	8 *	Ref. 207 • 206- ,
208	12 *	Ref. 207 • 208-183 ,
183	15 *	Ref. 208 • -183- ,
209	20 *	Ref. 209 • - , 187-
186	40 *	

△ Ref. 167 letras, solo "N" y "F" letters, only "N" and "F"

NEGRO

Ref.	↑cm	• - , ~
180	4 * +	Ref. 180
181	5 *	Ref. 181 • - ,

EJEMPLOS DE ACABADOS ESPECIALES

SPECIAL FINISHES EXAMPLES



ORO



ENVEJECIDO



CROMO MATE



PULIDO

* Avec numéros * Con numeri * Met nummers
 + Avec croix et étoiles + Con crocette e stelle + Met kruisjes en sterretjes

ROMANO ADHESIVO ROMANO ADHESIVE SYSTEM



PARA UNA ÓPTIMA ADHERENCIA:

- Limpiar y secar la superficie sobre la que se colocará la inscripción.
- Presionar las letras sobre la superficie.
- Es aconsejable realizar este trabajo a temperaturas comprendidas entre los 20° y 40° centígrados.
- Una vez colocado el adhesivo resiste temperaturas entre -30° y 100° centígrados.

FOR AN OPTIMAL ADHERENCE:

- Clean and dry the surface where the letters must be placed.
- Make pressure over the letters against the surface.
- It is advisable to make this work with temperatures between 20 and 40 centigrade degrees.
- The adhesive endures temperatures between -30 and +100 centigrade degrees.

ACABADO - SATINADO - FINISH

Ref.	↕ cm	• - ,
152	3 * +	Ref. 152
154	5 *	Ref. 152 • - 154,

ACABADO - CUERO - FINISH

Ref.	↕ cm	• - ,
132	3 * +	Ref. 132
134	5 *	

INGLÉS SOLDADO

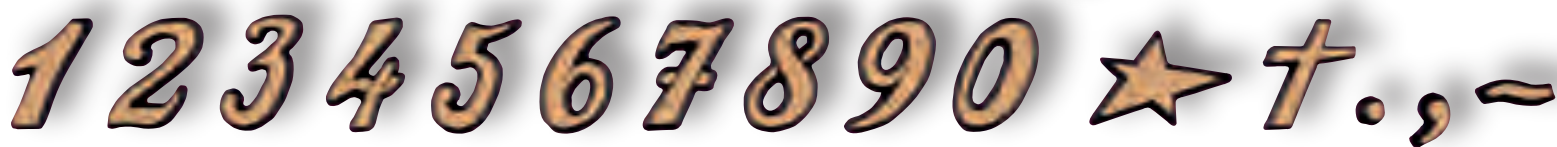

	Ref.	↕ cm
Minúsculas/Small Letters	242	2,5
Mayúsculas/Capital Letters	245	5
Números / Numbers * +	228	3
Signos / Marks • - ,	242	

Unidas con soldadura / Joined by welding

La referencia 245 sólo en iniciales y letras sueltas / Reference 245 only for initials and detached letters

- | | | |
|--------------------------|--------------------------|-------------------------|
| * Con números | * With numbers | * Com números |
| + Con cruces y estrellas | + With crosses and stars | + Com cruces e estrelas |

AZAHAR

Aa Bb Cc Dd
 Ee Ff Gg Hh
 Ii Jj Kk Ll
 Mm Nn Oo Pp
 Qq Rr Ss Tt
 Uu Vv Xx Yy
 Zz 1 2 3 4 5 6 7 8 9 0 ★ † . , -

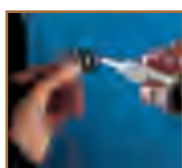

Azahar

Ref.	cm	Colocación	Collocation	Placement	Colocaçao	Colocazione	Plaatsing
220	3	Unida	Joined	Ensemblée	Junta	Unita	Samengevoegd
226	3	Inicio	Initial	Initial	Inicial	Iniziale	Initiaal
227	3	Final	Final	Final	Final	Finale	Eindletter
228	3	Suelta	Unattached	Seule	Solta	Sciolta	Losse letter
222	5,5	Unida	Joined	Ensemblée	Junta	Unita	Samenge voegd
223	5,5	Suelta	Unattached	Seule	Solta	Sciolta	Losse letter

242 • ~ , (Puntos, guiones y comas)

ITALICA



RECORTADAS DE CHAPA DE 4 mm DE ESPESOR
 UTILIZANDO TECNOLOGÍA DE CORTE POR AGUA.
 MADE IN 4mm THICKNESS SHEET BY WATER JET SYSTEM.

PARA FIJACIÓN 2 AGUJEROS / FIXATION BY 2 HOLES

A	B	C	D	E	a	b	c	d	e
26.9	29.7	19.3	28.1	15.8	13.13	11.12	9.45	13.13	9.49
F	G	H	I	J	f	g	h	i	j
22.2	19.6	27.5	19.0	24.0	7.59	13.13	12.37	7.69	7.77
K	L	M	N	Ñ	k	l	m	n	ñ
30.1	22.2	34.5	31.6	31.6	12.78	7.50	20.25	14.87	14.87
O	P	Q	R	S	o	p	q	r	s
17.4	24.3	22.3	27.8	20.1	10.98	12.43	12.88	11.20	8.02
T	U	V	W	X	t	u	v	w	x
22.1	21.5	19.3	27.8	23.7	7.50	13.13	13.38	18.69	12.12
Y	Z				y	z	-	+	*
23.7	20.4				14.62	11.01	8.87	8.87	9.73
					1	2	3	4	5
					7.32	8.9	8.8	7.2	9.2
					6	7	8	9	0
					8.90	8.45	7.95	8.90	7.63

A partir de los 3 cm, que es la altura mínima de una vocal minúscula, podemos fabricarlos con la altura que precisen.
 From 3 cm, that is the minimum height of one small vowel, we can make them with the height you need.

MAGNA

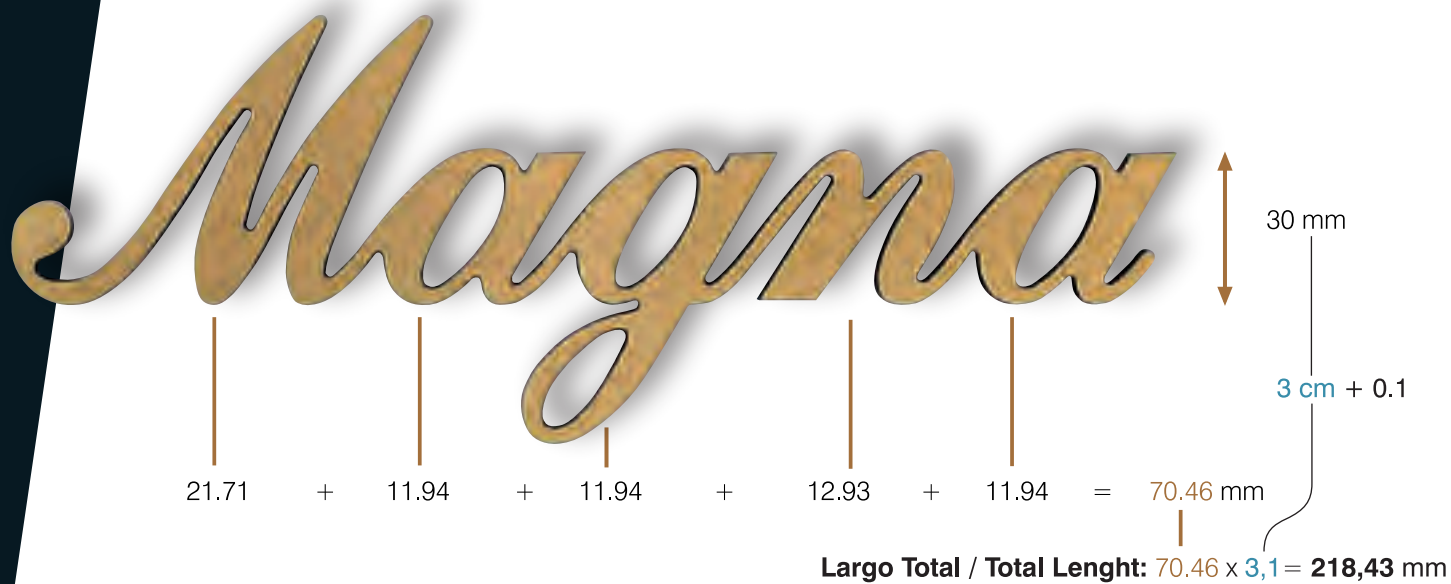

RECORTADAS DE CHAPA DE 4 mm DE ESPESOR
 UTILIZANDO TECNOLOGÍA DE CORTE POR AGUA.
 MADE IN 4mm THICKNESS SHEET BY WATER JET SYSTEM.
 PARA FIJACIÓN 2 AGUJEROS / FIXATION BY 2 HOLES

<i>A</i> 18.46	<i>B</i> 19.49	<i>C</i> 13.76	<i>D</i> 16.04	<i>E</i> 12.63	<i>a</i> 11.94	<i>b</i> 10.38	<i>c</i> 8.84	<i>d</i> 11.94	<i>e</i> 9.38	<i>f</i> 7.65	<i>g</i> 11.94			
<i>F</i> 14.66	<i>G</i> 13.31	<i>H</i> 18.77	<i>I</i> 14.66	<i>J</i> 13.98	<i>h</i> 12.56	<i>i</i> 6.54	<i>j</i> 6.94	<i>k</i> 11.33	<i>l</i> 6.52	<i>m</i> 18.57	<i>n</i> 12.93			
<i>K</i> 17.74	<i>L</i> 13.28	<i>M</i> 21.71	<i>N</i> 19.14	<i>Ñ</i> 19.14	<i>ñ</i> 12.93	<i>o</i> 10.47	<i>p</i> 12.56	<i>q</i> 11.94	<i>r</i> 7.40	<i>s</i> 8.70	<i>t</i> 6.52	<i>u</i> 11.97		
<i>O</i> 12.61	<i>P</i> 14.66	<i>Q</i> 12.76	<i>R</i> 17.69	<i>S</i> 14.47	<i>v</i> 11.60	<i>w</i> 16.07	<i>x</i> 10.82	<i>y</i> 11.94	<i>z</i> 9.83	- 9.33	+ 9.33	* 9.61		
<i>T</i> 14.66	<i>U</i> 15.69	<i>V</i> 12.76	<i>W</i> 18.98	<i>X</i> 16.02	<i>1</i> 8.65	<i>2</i> 8.78	<i>3</i> 8.98	<i>4</i> 7.60	<i>5</i> 9.36	<i>6</i> 8.71	<i>7</i> 7.47	<i>8</i> 8.69	<i>9</i> 8.71	<i>0</i> 8.57
<i>Y</i> 14.30	<i>Z</i> 14.30													

A partir de los 3 cm, que es la altura mínima de una vocal minúscula, podemos fabricarlos con la altura que precisen.
 From 3 cm, that is the minimum height of one small vowel, we can make them with the height you need.

MEMORIAL



13.9 + 11.2 + 13.9 + 11.9 + 12.1 + 6.1 + 11.7 + 10.2 = 91.0 mm

30 mm

3 cm

Largo Total / Total Length: $91.0 \times 3 = 273$ mm

**RECORTADAS DE CHAPA DE 4 mm DE ESPESOR
UTILIZANDO TECNOLOGÍA DE CORTE POR AGUA.
MADE IN 4mm THICKNESS SHEET BY WATER JET SYSTEM.**

PARA FIJACIÓN 2 AGUJEROS / FIXATION BY 2 HOLES

A B C D E F G H I

11.7 10.8 11.3 11.6 11.2 10.6 12.0 12.2 6.1

J K L M N Ñ O P Q

10.2 12.4 10.2 13.9 11.1 11.1 11.9 10.3 11.9

R S T U V W X Y Z

12.1 10.0 11.4 11.5 11.7 14.8 12.7 11.5 10.1

1 2 3 4 5

7.4 9.5 9.5 10.1 9.5

6 7 8 9 0

9.8 9.9 9.5 9.8 10.0

★ † ■ _ •

11.9 10.3 7.2 7.2 3.6

A partir de los 3 cm, que es la altura mínima, podemos fabricarlos con la altura que precisen.
From 3 cm, that is the mininum height, we can make them with the height you need.

HELVETICA UNIDA

JOINED HELVETICA

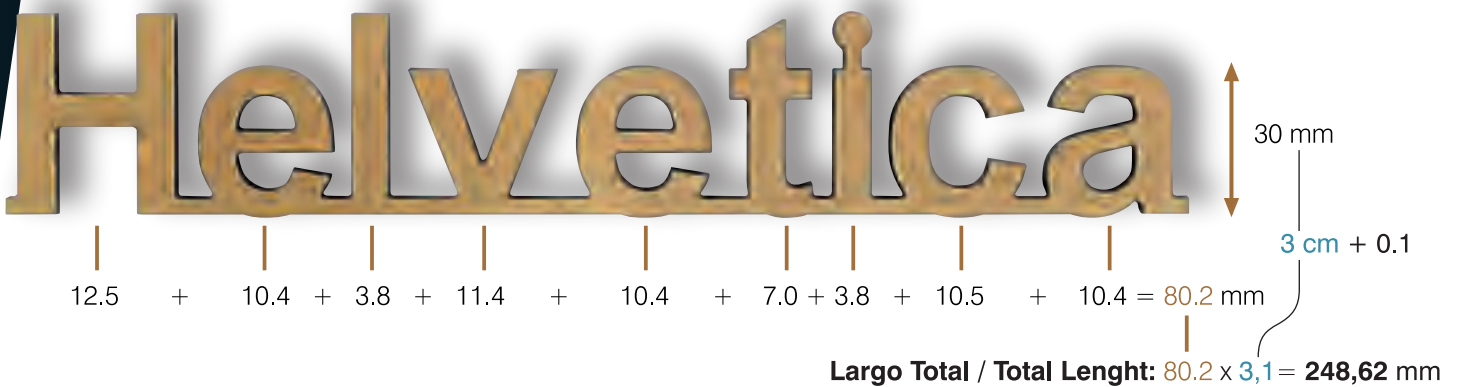
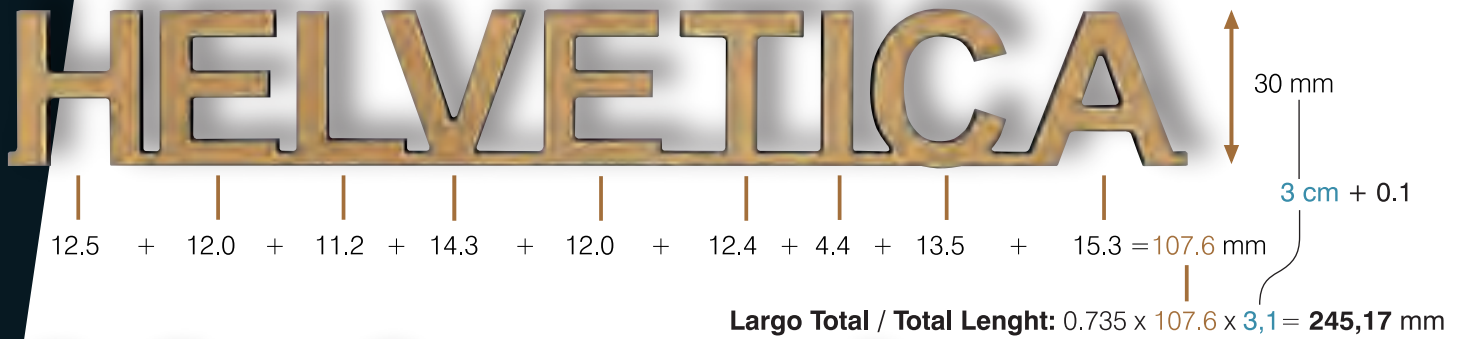

RECORTADAS DE CHAPA DE 4 mm DE ESPESOR
 UTILIZANDO TECNOLOGÍA DE CORTE POR AGUA.
 MADE IN 4mm THICKNESS SHEET BY WATER JET SYSTEM.
 PARA FIJACIÓN 2 AGUJEROS / FIXATION BY 2 HOLES

A B C D E E

15.3 13.0 13.5 13.0 12.0 11.0

G H I J K L M

14.4 12.5 4.4 10.3 13.9 11.2 14.8

N Ñ O P Q R

12.4 12.4 14.8 12.1 15.3 13.9

S T U V W X

12.7 12.4 12.5 14.3 19.5 14.3

Y Z 1 2 3 4 5 6 7 8 9 0 _ * ± .

14.4 12.7 7.6 10.8 10.7 11.4 10.8 10.7 10.5 10.6 10.7 10.5 7.2 12.6 11.2 4.0

a b c d e f g

10.4 10.8 10.5 10.8 10.4 7.9 10.8

h i j k l m n ñ

10.2 3.8 6.0 10.3 3.8 15.7 10.2 10.2

o p q r s t u

11.4 10.8 10.8 7.6 10.4 7.0 10.2

v w x y z

11.4 15.9 11.5 11.3 10.0

A partir de los 3 cm, que es la altura mínima de una vocal minúscula, podemos fabricarlos con la altura que precisen.
 También podemos suministrarlas sueltas
 From 3 cm, that is the minumum height of one small vowel, we can make them with the height you need. Also we can serve
 detached letters and numbers.

GÓTICA

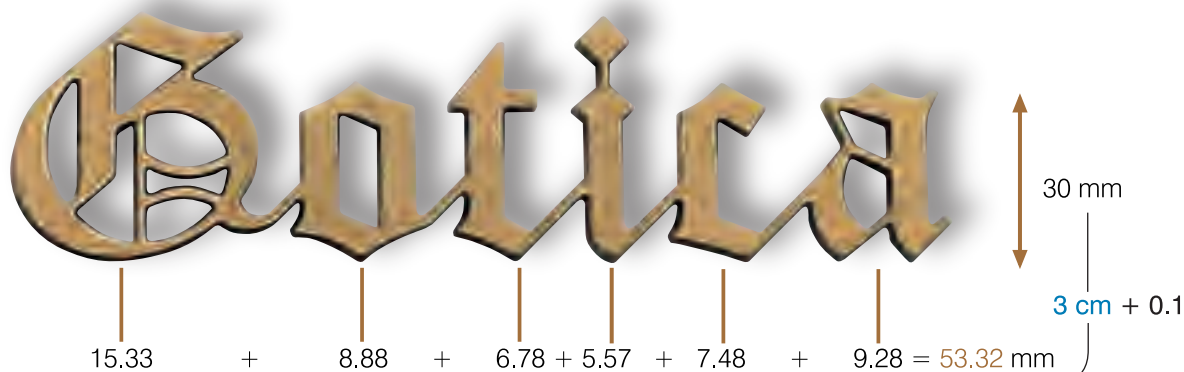

Largo Total / Total Length: 53.32 x 3,1 = 165,29 mm

In Loving Memory of

RECORTADAS DE CHAPA DE 4 mm DE ESPESOR
UTILIZANDO TECNOLOGÍA DE CORTE POR AGUA.
MADE IN 4mm THICKNESS SHEET BY WATER JET SYSTEM.

PARA FIJACIÓN 2 AGUJEROS / FIXATION BY 2 HOLES

A B C D E
14.02 15.94 13.80 16.26 14.08

F G H I J
17.05 15.33 16.34 12.49 14.08

K L M N Ñ
15.69 13.58 19.48 18.95 18.95

O P Q R S
16.34 16.13 16.34 16.01 16.58

T U V W X
15.75 16.58 14.57 19.31 14.02

Y Z + * - 1 2 3 4 5 6 7 8 9 0
15.22 13.07 9.63 10.27 7.69 6.09 8.61 8.56 8.80 8.24 8.41 8.54 8.28 8.44 8.46

a b c d e
9.28 8.94 7.48 9.20 7.80

f g h i j
6.37 10.60 8.92 5.57 6.58

k l m n ñ
9.21 5.63 14.63 10.54 10.54

o p q r s
8.88 9.56 9.45 8.82 9.22

t u v w x
6.78 10.39 9.25 13.31 10.29

y z
9.11 7.27

A partir de los 2,5 cm, que es la altura mínima de una vocal minúscula, podemos fabricarlos con la altura que precisen. También podemos suministrarlas sueltas.

From 2,5 cm, that is the minumum height of one small vowel, we can make them with the height you need. Also we can serve detached letters and numbers.

GRABACIONES

ENGRAVINGS GRAVAÇÕES GRAVURES INCISIONI GRAVEERWERK

CARÁCTER

1	ABCD	abcde
2	ABC	abcd
3	<i>ABC</i>	<i>abcdefg</i>
4	ABC	abcde
5	ABCDE	abcdefgh
6	<i>AB</i>	<i>abcde</i>

El tamaño de las letras puede ser el que se precise, la única limitación es el espacio disponible. Se considera normalizado cualquier tamaño no superior a 20 mm. A mayor tamaño el precio se incrementará proporcionalmente. El precio de una grabación se obtendrá multiplicando la cantidad de letras y signos por el precio unitario que cada carácter tenga asignado. Cualquier grabación se considerará, como mínimo, compuesta por 30 caracteres. El precio de la grabación en superficies curvas (libros) se incrementa en un 50%. Para evitar errores es importante que los pedidos de las grabaciones nos los envíen por fax o e-mail. Plazo de entrega: 3-5 días.

E

Any size of letters can be produced, the only limitation being the space available. Any size smaller than 20 mm. is considered standard. For larger sizes the price increases proportionally. The price of an engraving is obtained by multiplying the number of letters and signs by the unit price of each character. All engravings will be considered as a minimum of 30 characters. The price for engraving on curved surfaces (books) will be increased 50%. In order to avoid mistakes all engraving orders must be sent to us by fax or e-mail. Delivery time: 3-5 days.

ENG

O tamanho das letras pode ser o que se necessite, a unica limitação e o espaço disponível. Considera-se normalizado qualquer tamanho nao superior a 20 mm. sendo o preço para medidas superiores modificado proporcionalmente. O preço de uma gravação obtem-se multiplicando a quantidade de letras e signos pelo preço unitario que a cada caracter tenha sido atribuído. Qualquer gravação considera-se, como minima, composta por 30 caracteres. O preço das gravações em superficies curvas (livros) sofrem um agravamento de 50%. Tendo em vista evitar, erros, é importante que os pedidos de gravações nos sejam enviados por fax ou e-mail. Plazo de entrega: 3-5 dias.

PT

Le modèle des lettres peut-être celui précisé, l'unique limitation est l'espace disponible. On considère normalisé n'importe quel modèle non supérieur a 20 mm. Dans le cas d'une grandeur supérieure le prix sera augmenté proportionnellement. Le prix de la gravure s'obtiendra en multipliant la quantité de lettres et de signes par le prix unitaire de chaque caractère. Quelconque gravure sera considéré, comme composée d'un minium de 30 caracteres. Le prix des gravures à surfaces courbes (livres) augmente un 50%. Pour éviter erreurs c'est important que vos commandes de gravures soient envoyées par fax ou e-mail. Le delai de livraison 3-5 jours.

F

La grandezza delle lettere puo essere quella che si desidera, l'unico limite è lo spazio disponibile. Si considererà normale qualsiasi grandezza non superiore a 20 mm. Per una grandezza maggiore si incrementerà il prezzo in modo proporzionale, il prezzo di una incisione si otterrà moltiplicando il numero delle letters e dei segni per il prezzo unitario assegnato ad ogni carattere. Qualsiasi incisione si considererà, come minimo, composta da 30 caratteri. Su superfici ondulate (libri) subiranno un incremento del 50%. Per evitare gli errori è importante che i vostri ordini delle incisionesiano trasmessi via fax o e-mail. Termini di consegna: 3-5 giorni.

I

Elk model van letters kan worden gemaakt, allen zijn wij beperkt in de keuze van tussenruimte. Alle maten kleiner dan 20 mm. worden aanzien als standard. Ingeval van grotere afmetingen veshoogt de prijs proportioneel. De kostprijs van een graveerwerk bekomt men door het vermenigvuldigen vanhet totaal aantal letters/tekens met de eenheidsprijs van het type en is steeds de prijs van minimum 30 letters/tekens. De prijs voor een gravures naarons per fax ou e-mail verzonden worden. Levertijd: 3-5 dagen.

NL



⇒ Ref. 1357
cm 50 x 30 x 4

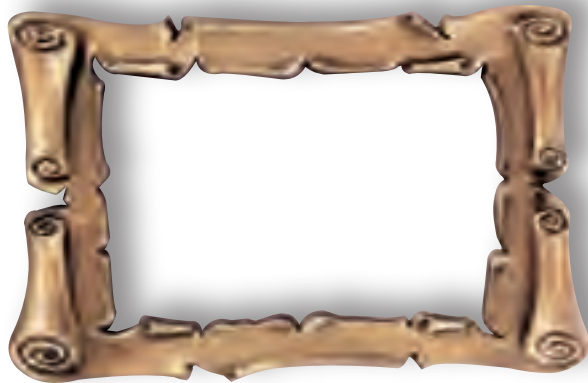

⇒ Ref. 1352
cm 34 x 21 x 3



EJEMPLO 1 Carácter 2



EJEMPLO 3 Carácter 6
Ref. 1352 + Ref. 360

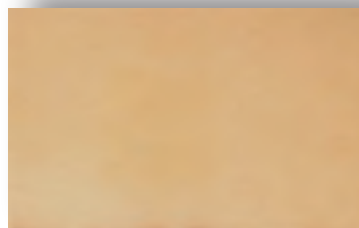

⇒ Ref. 360
mm 1,5
Precio/Price x cm²

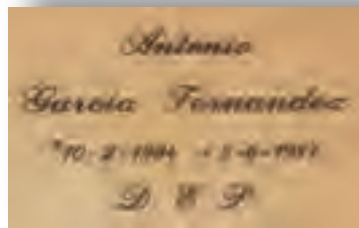

EJEMPLO 4 Carácter 6
Ref. 360
cm 25,5 x 17



EJEMPLO 2

- Ref. 1086
- ✂ Ref. 2045 I / 2045 D
- 🏺 Ref. 2560

MEDIDAS MÁXIMAS 1100 x 600 cm
 MAXIMUM SIZES
 PREGUNTEN CUÁL ES EL GRUESO MÁS ADECUADO
 ASK WHICH IS THE MOST APPROPRIATE THICKNESS

VERIFIQUEN EN TARIFA EL PRECIO DE LOS PERGAMINOS Y LIBROS GRABADOS EXPUESTOS COMO EJEMPLO
 CHECK PRICE OF ENGRAVED SCROLLS AND BOOKS EXAMPLES IN PRICE LIST



Ref. 1353
cm 28 x 20 x 2,5

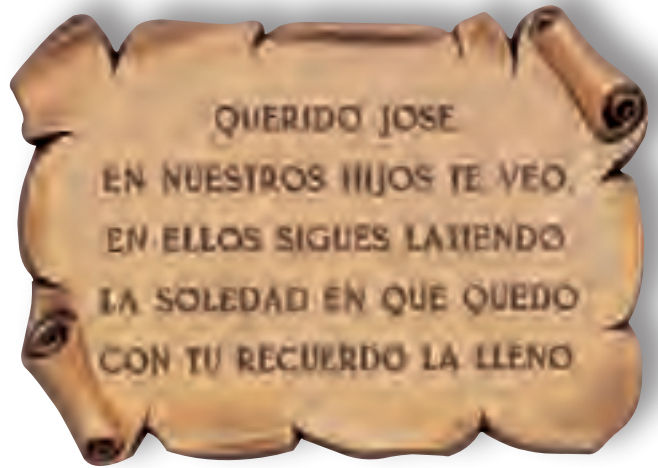

EJEMPLO 5 Carácter 2

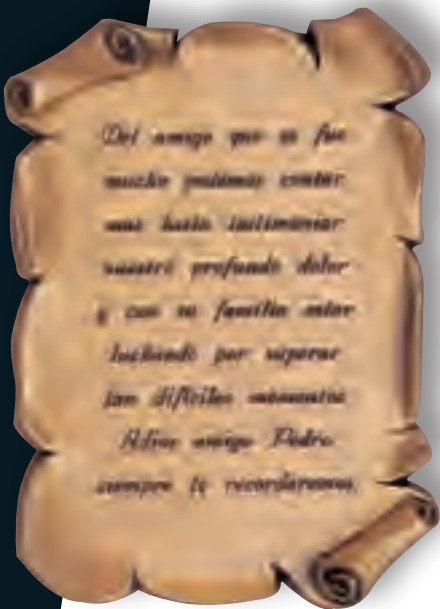

EJEMPLO 6 Carácter 3



EJEMPLO 7 Carácter 4

Ref. 1090



EJEMPLO 8 Carácter 6



EJEMPLO 9 Carácter 1

Ref. 1342



EJEMPLO 10 Carácter 5

VERIFIQUEM NA TABELA O PREÇO DOS PERGAMINHOS E LIVROS GRAVADOS EXPOSTOS COMO EXEMPLO
VERIFIER AVEC LA TARIF LE PRIX DES PARCHEMINS ET DES LIVRES GRAVÉS EXPOSÉS COMME EXEMPLE



Ref. 1359
cm 20 x 14 x 1,5

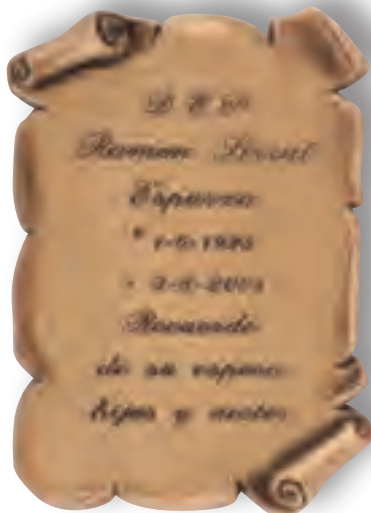

EJEMPLO 1 Carácter 6

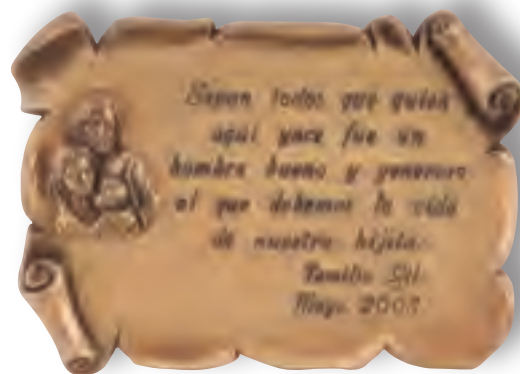

EJEMPLO 12 Carácter 3
Ref. 1341

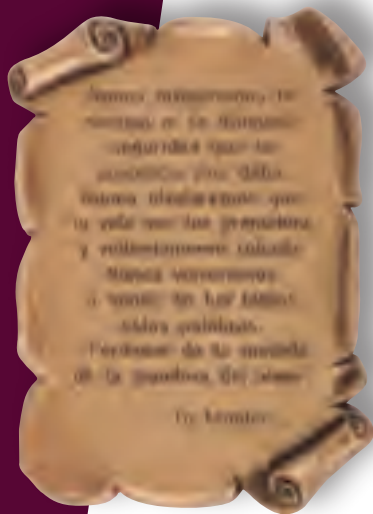

EJEMPLO 13 Carácter 1



EJEMPLO 14 Carácter 2
Ref. 1508 I

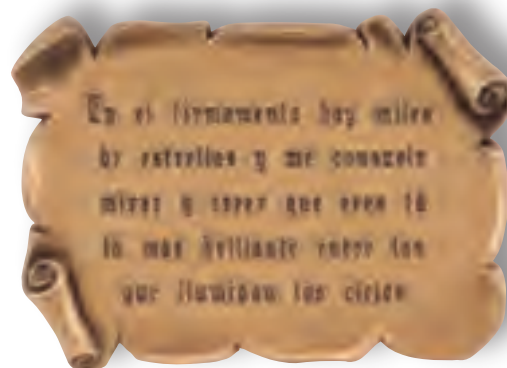

EJEMPLO 15 Carácter 5



Ref. 1351
cm 15 x 11 x 1,5



EJEMPLO 16 Carácter 1



EJEMPLO 17 Carácter 4
Ref. 1901 D

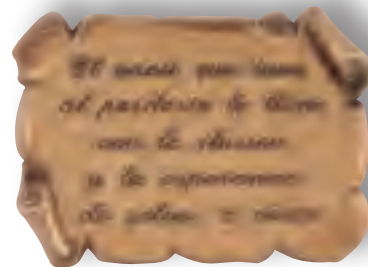

EJEMPLO 18 Carácter 6



Ref. 1382
cm 9 x 3,5 x 0,5



EJEMPLO 19 Carácter 1



EJEMPLO 20 Carácter 6



EJEMPLO 21 Carácter 2



Ref. 1380
cm 7 x 5 x 0,5

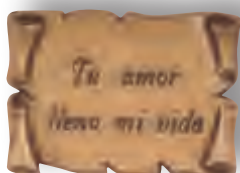

EJEMPLO 22 Carácter 3



EJEMPLO 23 Carácter 5



EJEMPLO 24 Carácter 4



⇒ Ref. 5532
cm 26 x 18 x 5
⇒ Ref. 5534
cm 36,5 x 29 x 6



⇒ Ref. 5535
cm 41,5 x 25 x 4



EJEMPLO 25 Ref. 5534 - Carácter 4



EJEMPLO 26 Ref. 5532 - Carácter 1



EJEMPLO 27 Ref. 5532 - Carácter 3
○ Ref. 1080



EJEMPLO 28 Ref. 5534 - Carácter 6
○ Ref. 1070

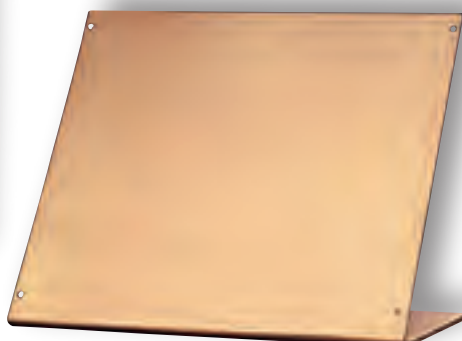

- Ref. 1351 S (□ 1351)
 - Ref. 1353 S (□ 1353)
 - Ref. 1357 S (□ 1357)
 - Ref. 1359 S (□ 1359)
-
- Ref. 5532 S (□ 5532)
 - Ref. 5534 S (□ 5534)
 - Ref. 5535 S (□ 5535)

VERIFIQUEN EN TARIFA EL PRECIO DE LOS PERGAMINOS Y LIBROS GRABADOS EXPUESTOS COMO EJEMPLO
CHECK PRICE OF ENGRAVED SCROLLS AND BOOKS EXAMPLES IN PRICE LIST

PLACAS FUNDIDAS CON TEXTOS E IMÁGENES EN RELIEVE

CAST PLAQUES WITH RAISED TEXTS AND IMAGES

PLACAS FUNDIDAS CON TEXTO EN RELIEVE - TIPOGRAFÍA, FORMATOS Y MEDIDAS NORMALIZADAS
CAST PLAQUES WITH RAISED TEXTS - TYPOGRAPHY, SHAPES AND SIZES STANDART

FORMATO OVAL / OVAL SHAPE

FORMATO RECTANGULAR / RECTANGULAR SHAPE



EJEMPLO 29 30 x 20 x 1 cm



EJEMPLO 30 28 x 20 x 1 cm

⇒ Ref. 495	cm 30 x 20 x 1 cm
⇒ Ref. 496	cm 35 x 25 x 1 cm

⇒ Ref. 490	cm 23 x 16 x 1 cm
⇒ Ref. 491	cm 28 x 20 x 1 cm
⇒ Ref. 492	cm 38 x 24 x 1 cm

LA EXTENSIÓN DEL TEXTO NO AFECTA AL PRECIO · SIZE OF TEXT DOES NOT AFFECT THE PRICE



TRABAJOS ESPECIALES SPECIAL WORKS

MEDIDAS MÁXIMAS 95 x 52 cm
MAXIMUM SIZES

CON CUALQUIER FORMATO, TIPOGRAFÍA Y MOTIVOS
WITH ANY SHAPE, TYPOGRAPHY AND MOTIFS

	Superficie · Surface	Grueso · Depth
⇒ Ref. 500	≥ 1000 cm ²	1 cm
⇒ Ref. 502	< 1000 cm ² ≥ 2500 cm ²	1 cm
⇒ Ref. 504	< 2500 cm ² ≥ 4950 cm ²	1 cm

EL DISEÑO EN SOPORTE INFORMÁTICO DEBE SERNOS ENVIADO JUNTO CON EL PEDIDO
THE DESIGN MADE BY COMPUTER PROCESS MUST BE SENT TO US TOGETHER WITH THE ORDER

CUALQUIER PLACA INFERIOR A 1000 cm² SE CONSIDERARÁ A EFECTOS DE PRECIO COMO UNA PLACA DE 1000 cm²
ANY PLAQUE SMALLER THAN 1000 cm² WILL BE CONSIDERED FOR PRICING AS A PLAQUE OF 1000 cm²



cm 12,5 x 6,5



cm 30,5 x 44



cm 23 x 26



cm 26 x 27



cm 32,5 x 25,5

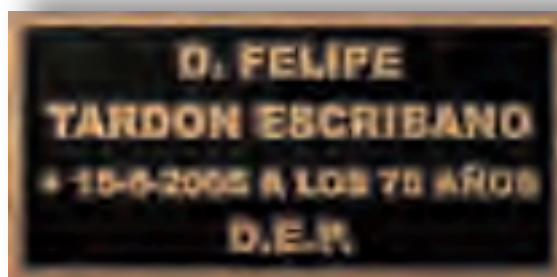

cm 24 x 12

CONSULTEN PRECIOS · ASK FOR PRICES

EL DISEÑO EN SOPORTE INFORMÁTICO DEBE SER NOS ENVIADO JUNTO CON EL PEDIDO
THE DESIGN MADE BY COMPUTER PROCESS MUST BE SENT TO US TOGETHER WITH THE ORDER
CUALQUIER PLACA INFERIOR A 1000 cm² SE CONSIDERARÁ A EFECTOS DE PRECIO COMO UNA PLACA DE 1000 cm²
ANY PLAQUE SMALLER THAN 1000 cm² WILL BE CONSIDERED FOR PRICING AS A PLAQUE OF 1000 cm²

PLACAS INYECTADAS CON TEXTO EN RELIEVE - PLAQUES WITH EMBOSS-INJECTED TEXT
PLAQUES INJECTÉES AVEC TEXTE EN RELIEF - TARGHE INIETTATE CON TESTO IN RILIEVO
PLACAS INYECTADAS COM TEXTO EN RELEVO - GE-INJECTEERDE PLATEN MET RELIEF-LETTERS



Ref. 7628
cm 10 x 2



cm 8 x 2



cm 10,5 x 6



Ø 6 cm



cm 9,5 x 5,5



cm 8 x 2,2



cm 10 x 3

Fabricamos placas inyectadas de cualquier tamaño y con el texto que se precise. Consulten precios. Cantidad mínima 500 unidades.

We manufacture injected plaques in any size and with the text required. Consult our prices. Minimum quantity: 500 units.

Fabricamos placas inyectadas de todos os tamanhos qualquer que seja o texto. Favor consultarem preços. Quantidade mínima 500 unidades.

Nous fabriquons des plaques injectées en plusieurs mesures avec le texte précis. Consulter les prix. Quantités minimum 500 unités.

Fabbrichiamo targhe iniettate di qualsiasi grandezza e con il testo di cui si ha bisogno. Consultate i prezzi. Quantità minima 500 unità.

Wij maken ge-injecteerde platen in diverse maten, met gelijk welke tekst. Raadpleeg ons voor de prijs, rekening houdend met een minimum afname van 500 stuks.

REPRODUCCIONES FOTOGRÁFICAS EN BRONCE MEDIANTE GRABADO TRIDIMENSIONAL

PHOTOGRAPHIC REPRODUCTIONS IN BRONZE BY THREE-DIMENSIONAL ENGRAVING



EJEMPLO 51 cm 40,5 x 20,5



EJEMPLO 54 cm 30,5 x 25,5

PIDA INFORMACIÓN SOBRE LA NECESARIA CALIDAD DE LA FOTOGRAFÍA A REPRODUCIR Y EL MEDIO MÁS ADECUADO DE ENVIÁRNOSLA.

PLAZO DE ENTREGA: 3 MESES

DE SER NECESARIO REALIZAR UN FOTOMONTAJE, LA ACEPTACIÓN POR ESCRITO DEL BOCETO PROPUESTO SERÁ CONDICIÓN IMPRESCINDIBLE PARA LA EJECUCIÓN DEL TRABAJO.

ASK FOR INFORMATION ABOUT THE REQUIRED QUALITY OF THE PHOTOGRAPHY TO BE REPRODUCED AND THE BEST WAY FOR SENDING IT TO US.

DELIVERY TIME: 3 MONTHS

IF WE MUST MAKE A PHOTOMONTAGE, YOUR ACCEPTANCE IN WRITING WILL BE ABSOLUTELY NECESSARY IN ORDER TO MAKE THE WORK.

REPRODUCCIONES FOTOGRÁFICAS EN BRONCE
MEDIANTE GRABADO TRIDIMENSIONAL



EJEMPLO 55 cm 20,5 x 12,5



EJEMPLO 50 cm 45,5 x 15

PHOTOGRAPHIC REPRODUCTIONS IN BRONZE
BY THREE-DIMENSIONAL ENGRAVING



EJEMPLO 58 cm 15 x 11



EJEMPLO 57 cm 15 x 11



EJEMPLO 53 cm 30,5 x 23



EJEMPLO 52 cm 30,5 x 23



⇒ Ref. 3184 cm 8 x 6
 ⇒ Ref. 3186 cm 10 x 8
 ⇒ Ref. 3185 cm 9 x 7



⇒ Ref. 2576 cm 9 x 7
 ⇒ Ref. 2578 cm 12 x 9
 ⇒ Ref. 2577 cm 10 x 8



⇒ Ref. 1050 cm 8 x 6
 ⇒ Ref. 1052 cm 10 x 8
 ⇒ Ref. 1051 cm 9 x 7
 ⇒ Ref. 1053 cm 12 x 9



⇒ Ref. 1090 cm 8 x 6
 ⇒ Ref. 1092 cm 10 x 8
 ⇒ Ref. 1091 cm 9 x 7
 ⇒ Ref. 1093 cm 12 x 9



⇒ Ref. 1070 cm 8 x 6
 ⇒ Ref. 1072 cm 10 x 8
 ⇒ Ref. 1071 cm 9 x 7
 ⇒ Ref. 1073 cm 12 x 9



⇒ Ref. 1085 cm 8 x 6
 ⇒ Ref. 1087 cm 10 x 8
 ⇒ Ref. 1086 cm 9 x 7
 ⇒ Ref. 1088 cm 12 x 9

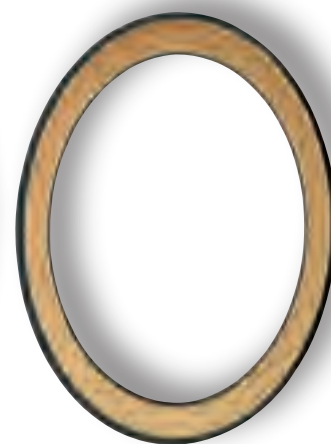

⇒ Ref. 1100 cm 7,5 x 5,5

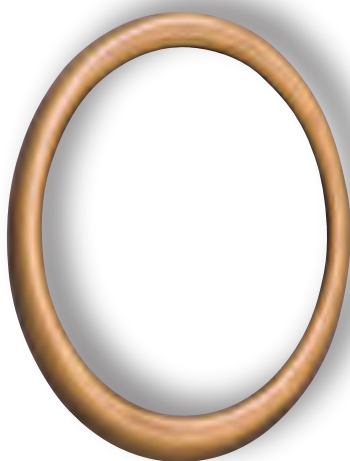

⇒ Ref. 1080 cm 8 x 6
 ⇒ Ref. 1082 cm 10 x 8
 ⇒ Ref. 1084 cm 15 x 11
 ⇒ Ref. 1081 cm 9 x 7
 ⇒ Ref. 1083 cm 12 x 9



⇒ Ref. 1020 cm 8 x 6
 ⇒ Ref. 1021 cm 9 x 7



⇒ Ref. 1060 cm 8 x 6
 ⇒ Ref. 1062 cm 10 x 8
 ⇒ Ref. 1061 cm 9 x 7
 ⇒ Ref. 1063 cm 12 x 9



⇒ Ref. 2471
cm 9 x 7

⇒ Ref. 2472
cm 10 x 8

⇒ Ref. 2473
cm 12 x 9

⇒ Ref. 2474
cm 15 x 11



⇒ Ref. 2546
cm 9 x 7

⇒ Ref. 2547
cm 10 x 8

⇒ Ref. 2548
cm 12 x 9



⇒ Ref. 2536
cm 9 x 7

⇒ Ref. 2537
cm 10 x 8

⇒ Ref. 2538
cm 12 x 9



⇒ Ref. 2476
cm 12 x 9

⇒ Ref. 2478
cm 15 x 11



⇒ Ref. 2748
cm 9 x 7

⇒ Ref. 2749
cm 10 x 8

⇒ Ref. 2750
cm 12 x 9

⇒ Ref. 2751
cm 15 x 11



⇒ Ref. 2738
cm 12 x 9

⇒ Ref. 2740
cm 15 x 11



SATINADO	PULGADAS INCHES	PULGADAS INCHES
⇒ Ref. 1030	2 ¹ / ₄ x 2 ³ / ₄	⇒ Ref. 1033 3 ³ / ₄ x 5
⇒ Ref. 1031	2 ⁵ / ₈ x 3 ³ / ₈	⇒ Ref. 1034 4 ¹ / ₄ x 6
⇒ Ref. 1032	3 ¹ / ₄ x 4 ¹ / ₄	⇒ Ref. 1035 5 x 7



⇒ Ref. 1102
cm 9 x 7

⇒ Ref. 1103
cm 10 x 8

⇒ Ref. 1104
cm 12 x 9

⇒ Ref. 1105
cm 15 x 11



⇒ Ref. 2581
cm 10 x 8

⇒ Ref. 2583
cm 12 x 9

ALSO AVAILABLE IN POLISHED AND VARNISHED

LE MISURE INDICANO LE DIMENSIONI DELLA FOTOCERAMICA · LES MESURES INDIQUENT LES DIMENSIONS DE LA PHOTOCÉRAMICA
DE AFMETINGEN WORDEN WEERGEVEEN DOOR DE FOTO'S



⇒ Ref. 2725 ⇒ Ref. 2726
cm 12 x 9 cm 15 x 11



⇒ Ref. 2630 ⇒ Ref. 2631
cm 12 x 9 cm 15 x 11



⇒ Ref. 2710 ⇒ Ref. 2711
cm 12 x 9 cm 15 x 11



⇒ Ref. 2728 ⇒ Ref. 2730
cm 12 x 9 cm 15 x 11



⇒ Ref. 2633 ⇒ Ref. 2635
cm 12 x 9 cm 15 x 11



⇒ Ref. 2713 ⇒ Ref. 2715
cm 12 x 9 cm 15 x 11

LAS MEDIDAS INDICAN LAS DIMENSIONES DE LA FOTOCERÁMICA · THE MEASURES SHOW THE PHOTOSIZES · AS MEDIDAS INDICAM AS DIMENSÕES DA FOTOCERÂMICA



♀ Ref. 5905
cm 45 x 17,5
☐ Ø 14,5 cm



○ Ref. 4115
☐ 10 cm
↔ 100 cm



○ Ref. 4116
☐ 7,5 cm
↔ 100 cm



⇒ Ref. 4119
Ø 5 cm



○ Ref. 1360
Ø 11,5 cm
▬ Ø 1,2 † 8,5 cm



○ Ref. 1367
Ø 11,5 cm
▬ Ø 1,2 † 8,5 cm



○ Ref. 1361
○ Ref. 1361C
Ø 11,5 cm
▬ Ø 1,2 † 8,5 cm



○ Ref. 3756
Ø 8 cm
▬ Ø 0,8 † 5,5 cm



○ Ref. 3754
Ø 8 cm
▬ Ø 0,8 † 5,5 cm





○ Ref. 3753
Ø 8,5 cm
▬ Ø 0,6 † 6,5 cm





○ Ref. 3750
Ø 8,5 cm
▬ Ø 0,6 † 4,5 cm

○ Ref. 3752
Ø 10 cm
▬ Ø 0,8 † 7,5 cm





○ Ref. 1365
 Ø 11,5 cm
 Ø 1,2 † 8,5 cm
 ○ Ref. 1365 L
 Ø 11,5 cm
 Ø 1,2 † 11,5 cm







○ Ref. 1364
 Ø 11 cm
 Ø 1,2 † 8 cm
 ○ Ref. 1364 L
 Ø 11 cm
 Ø 1,2 † 12,5 cm



D Ref. 3757
 cm 16 x 16 x 1
 Ø 0,6 † 4 cm
 ○ Ref. 3757 D
 cm 16 x 16 x 2
 Ø 1 † 9,5 cm
 ○ Ref. 3757 M
 cm 16 x 16 x 2
 Ø 1 † 9,5 cm





D Ref. 3759
 cm 13 x 13 x 1,5
 Ø 0,6 † 4,5 cm
 ○ Ref. 3759 D
 cm 13 x 13 x 3
 Ø 0,6 † 4,5 cm

D Ref. 3758
 cm 16 x 16 x 1
 Ø 0,6 † 5 cm
 ○ Ref. 3758 D
 cm 16 x 16 x 2 m
 Ø 1 † 9,5 cm



Ref. 4207
 cm 8,5 x 4
 Ref. 4205 L



← Ref. 4211 I → Ref. 4211 D
 cm 19,5 x 7,5 cm 19,5 x 7,5
 14,5 cm  14,5 cm



Ref. 1160
cm 4 x 4
▽ 23 x 60
✕ Ref. 1160 S



Ref. 1132
cm 4 x 4
▽ 23 x 60



Ref. 1130
cm 4 x 4
▽ 23 x 60



Ref. 1162
cm 5 x 5
▽ 23 x 60
✕ Ref. 1162 S



Ref. 1135
Ø 5 cm
▽ 23 x 60
Ref. 1137
M4 x 4,5 cm



Ref. 1134
Ø 5 cm
▽ 23 x 60



Ref. 1136
Ø 5 cm
▽ 23 x 60



Ref. 1138
Ø 5 cm
▽ 23 x 60



Ref. 1156
cm 3,5 x 3,5
▽ 23 x 60
Ref. 1157
M4 x 45



Ref. 1165
cm 3,5 x 3,5
▽ 23 x 60
✕ Ref. 1165 S

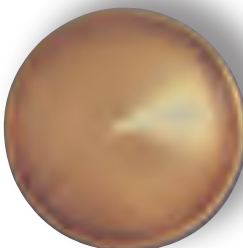

Ref. 5910
Ø 3 cm
▽ 23 x 60
✕ Ref. 5910 S

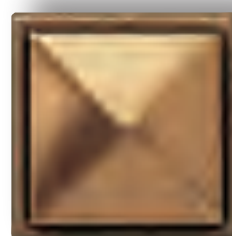

Ref. 1154 **Ref. 1155**
cm 2,5 x 2,5 cm 3 x 3
▽ 23 x 60 ▽ 23 x 60
Ref. 1158 **Ref. 1159**
M4 x 45 M4 x 45



Ref. 1240
Ø 3 cm
▽ 23 x 60
Ref. 1241
▽ GALVANIZADO



Ref. 1250
Ref. 1250 C
◻ 1,8 x 1,6 cm
▽ 23 x 60



Ref. 4042
cm 6,5
▽ 23 x 60

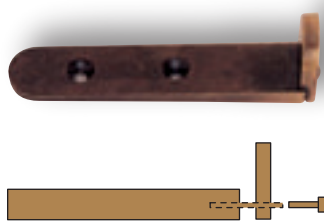

Ref. 4040
cm 8,5



Ref. 4104 6,5 cm
Ref. 4105 8 cm
Ref. 4106 10 cm
Ref. 4107 13 cm
Ref. 4108 16 cm



Ref. 1209
 Ø 5 cm
 M6 x 9 cm



Ref. 1204
 Ø 5,8 cm
 M6 x 9 cm



Ref. 1207
 Ø 5 cm
 M6 x 9 cm



Ref. 1208
 Ø 5 cm
 M6 x 9 cm



Ref. 1206
 Ø 5 cm
 M6 x 8 cm



Ref. 1237
 Ø 5 cm
 M8 x 9 cm

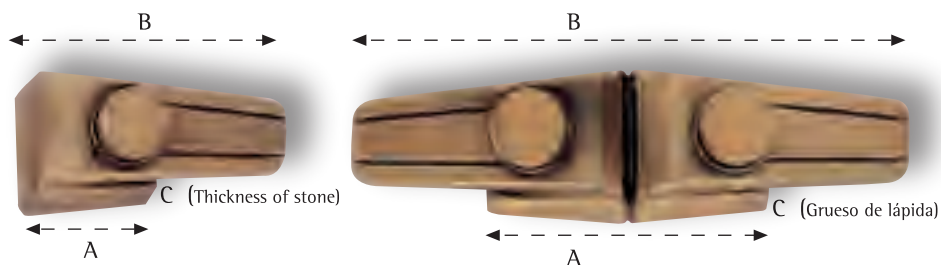

	A	B	C
Ref. 1282	3,5	7	1,8-2,5 cm
Ref. 1282C			
Ref. 1283	3,5	7	2,6-3 cm
Ref. 1283C			
	M8 x 6 cm	⊗ M8	

	A	B	C
Ref. 1233	7	14	1,8-2,5 cm
Ref. 1234	7	14	2,6-3 cm
	M8 x 6 cm	⊗ M8	

Ref. 1284
 cm 3 x 6,5
 M5 x 3 cm
 TAC05



Ref. 1235
 Ø 5 cm
 M8 x 9 cm



	A	B	C
Ref. 1286	5,3	6,6	1,5-2,5 cm
	M8 x 10 cm	TAC08	



	A	B	C
Ref. 1285	6	10,5	1,5-2,5 cm
Ref. 1287	8	12,7	1,5-2,5 cm
	M8 x 10 cm	TAC08	



Ref. 4007
 cm 11 x 3,5 x 1,8



grueso piedra / stone thickness
Ref. 1296 2 cm
Ref. 1297 3 cm
 cm 12,5 x 6 x 5,5

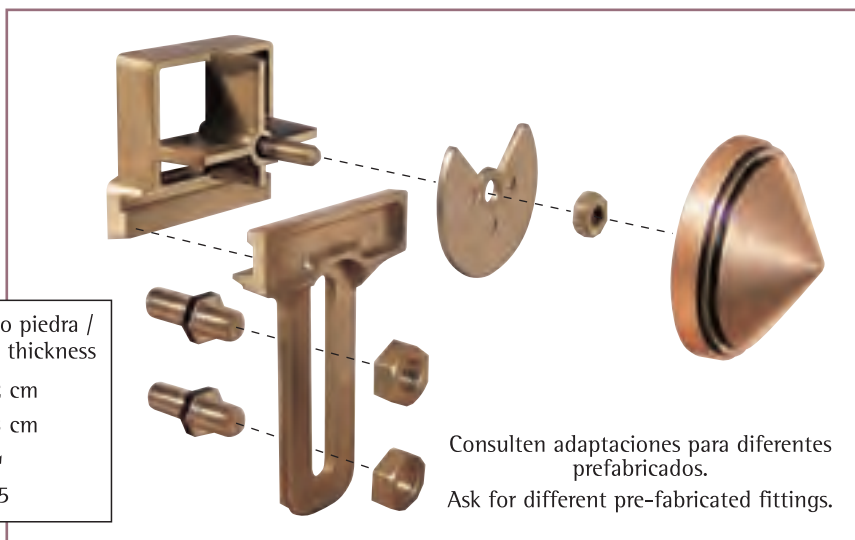

Consulten adaptaciones para diferentes prefabricados.
 Ask for different pre-fabricated fittings.

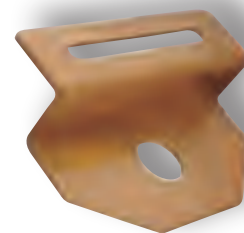

Ref. 4008
 cm 6,5 x 5 x 1,8



⇒ Ref. 5415
↔ ↓ ∇
cm 25 x 7 x 4,5



⇒ Ref. 5409
↓ ↔ ∇
cm 9 x 13 x 7,5



Ø Ref.	Ø columna	
5020	5020C	2 cm } Ø columna
5025	5025C	2,5 cm } Ø colonne
5030	5030C	3 cm } Ø colonna
5035	5035C	3,5 cm } Ø colonne
5040	5040C	4 cm } Ø colonna
5045	5045C	4,5 cm } Ø column
5050	5050C	5 cm
5055	5055C	5,5 cm

Ref.	pilastra	
5120	5120C	2 cm } pilastra
5125	5125C	2,5 cm } pilastre
5130	5130C	3 cm } pilastro
5135	5135C	3,5 cm } pilaster
5150	5150C	5 cm

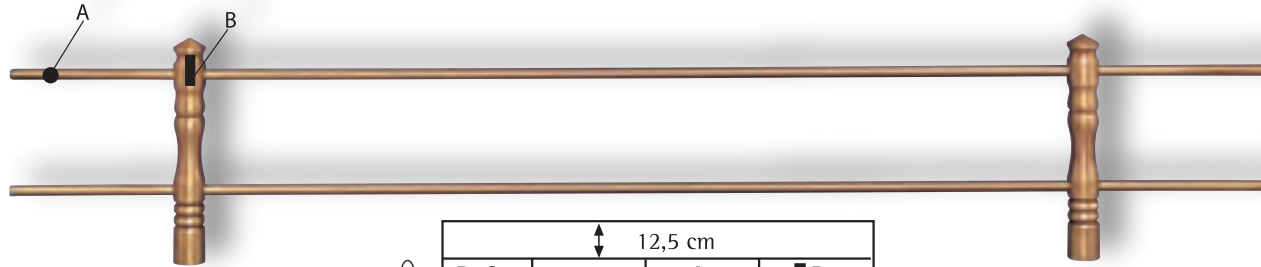

Ref.	cm ↔	•A	■B
5270	70	2	2
5280	80	2	2
5380	80	2	3
5385	85	2	3
5390	90	2	3

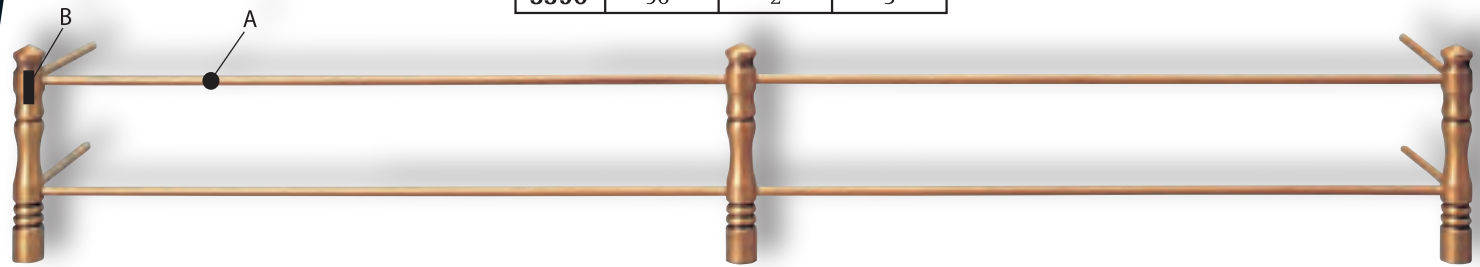

Ref.	cm ↔	•A	■B
5380 L	80	2	3
5385 L	85	2	3
5390 L	90	2	3

Sobre pedido fabricamos cualquier medida.
Can be manufactured in any size.

Si possono fabbricare di qualsiasi misura.
Zij kunnen in om't even welke afmeting gemaakt worden

Podem fabricar-se de qualquer medida.
Il peuvent être fabriqués dans n'importe quelle mesure.



Ref. GL



Ref. BA



Ref. GF

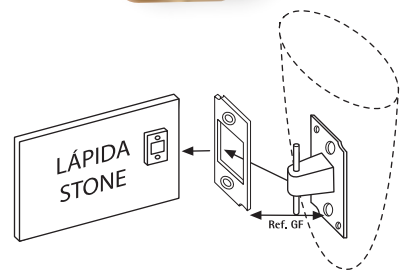
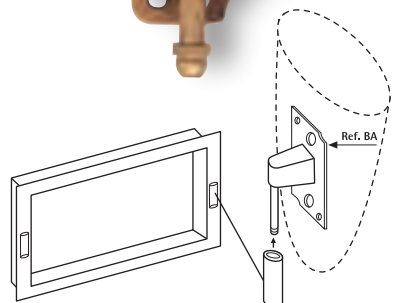
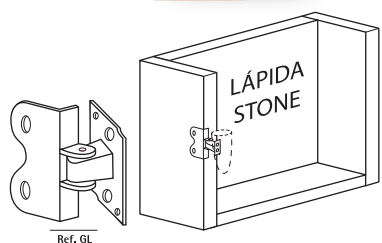

- PARA BUCAROS/
FOR VASES**
- Ref. 2555
 - Ref. 2557
 - Ref. 2558
 - Ref. 2559
 - Ref. 2590
 - Ref. 2591
 - Ref. 2592
 - Ref. 2692
 - Ref. 2693
 - Ref. 2694



Ref. 3180
cm 43 x 25 x 3



Ref. 3184
cm 8,5 x 6,5
Ref. 3185
cm 9 x 7
Ref. 3186
cm 10 x 8

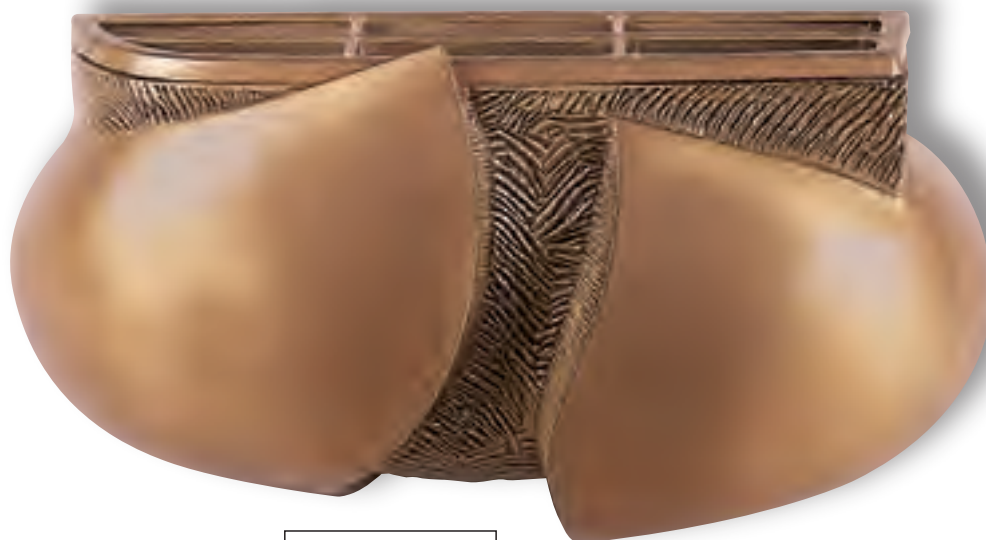

Ref. 3181
cm 30 x 16 x 9
D 66
R 66



Ref. 3183
cm 20 x 10 x 8 cm
V 1



Ref. 3182
cm 18,5 x 13,5 x 8
D 130
R 130



Ref. 3183 B
cm 22 x 10 x 7,5
5,5 cm
V 1



∅ Ref. 2748 cm 9 x 7	∅ Ref. 2750 cm 12 x 9
∅ Ref. 2749 cm 10 x 8	∅ Ref. 2751 cm 15 x 11



∅ Ref. 2738 cm 12 x 9
∅ Ref. 2740 cm 15 x 11



∅ Ref. 2554 cm 20 x 9 x 10	∅ Ref. 2553 T cm 25 x 9 x 9
∅ Ref. 2554 T cm 20 x 9 x 9	∅ V 2
∅ V 1	



∅ Ref. 2550 cm 18 x 18 x 12
∅ Ref. 2550 T cm 18 x 18 x 11,5
∅ D 121
∅ R 12



∅ Ref. 2552 cm 20 x 11 x 12	∅ Ref. 2551 T cm 28,5 x 14 x 14
∅ Ref. 2552 T cm 20 x 11 x 11	∅ D 62
∅ D 3318	∅ R 62
∅ R 60	



∅ Ref. 2594
cm 18 x 12
♀ Ref. 2594 T
cm 18 x 11
∇ V6



∅ Ref. 2591
cm 19,5 x 11
♀ Ref. 2591 T
cm 19,5 x 10
∇ ⊗ RD 59



∅ Ref. 2595
cm 22,5 x 11
♀ Ref. 2595 T
cm 22,5 x 10
💧 V 1



♀ Ref. 2594 B
cm 20 x 11
☞ 7 cm
∇ V 6



♀ Ref. 2591 B
cm 22 x 10
☞ 7 cm
∇ ⊗ RD 59



♀ Ref. 2595 B
cm 24 x 10
☞ 5,5 cm
💧 V 1



∅ Ref. 2596
cm 22,5 x 11

♀ Ref. 2596 T
cm 22,5 x 10

🔥 V 1



∅ Ref. 2592
cm 19,5 x 11

♀ Ref. 2592 T
cm 19,5 x 10

∇ ⊗ RD 59



∅ Ref. 2590
cm 19,5 x 11

♀ Ref. 2590 T
cm 19,5 x 10

∇ ⊗ RD 590



∅ Ref. 2593
cm 18 x 12

♀ Ref. 2593 T
cm 18 x 11

∇ V 6



♀ Ref. 2596 B
cm 24 x 10

📏 5,5 cm

🔥 V 1



♀ Ref. 2592 B
cm 22 x 10

📏 7 cm

∇ ⊗ RD 59



♀ Ref. 2590 B
cm 22 x 10

📏 7 cm

∇ ⊗ RD 590



♀ Ref. 2593 B
cm 20 x 11

📏 7 cm

∇ V 6



∅ Ref. 2540
cm 21 x 12 x 13

♀ Ref. 2540 T
cm 21 x 12
∇ ⊗ RD 59



∅ Ref. 2543
cm 22 x 9,5 x 10,5

♀ Ref. 2543 T
cm 22 x 9,5
♠ V 1



∅ Ref. 2546
cm 9 x 7

∅ Ref. 2547
cm 10 x 8

∅ Ref. 2548
cm 12 x 9



∅ Ref. 2541
cm 21 x 12 x 13

♀ Ref. 2541 T
cm 21 x 12
∇ ⊗ RD 59



∅ Ref. 2544
cm 22 x 9,5 x 10,5

♀ Ref. 2544 T
cm 22 x 9,5
♠ V 1



∅ Ref. 2536
cm 9 x 7

∅ Ref. 2537
cm 10 x 8

∅ Ref. 2538
cm 12 x 9



∅ Ref. 2471
cm 9 x 7

∅ Ref. 2472
cm 10 x 8

∅ Ref. 2473
cm 12 x 9

∅ Ref. 2474
cm 15 x 11



∅ Ref. 2476
cm 12 x 9

∅ Ref. 2478
cm 15 x 11



∅ Ref. 2483
cm 6 x 3,5 x 3,6

∅ Ref. 2481
cm 12 x 7 x 7,5

∅ Ref. 2481 T
cm 12 x 7 x 7
∇ ⊗ D 82 M

∅ Ref. 2482
cm 16 x 10 x 11

∅ Ref. 2482 T
cm 16 x 10 x 10
∇ ⊗ RD 2482



∅ Ref. 2479
cm 8 x 3,5 x 3,7
∅ V 10

∅ Ref. 2480
cm 20 x 9,5 x 11

∅ Ref. 2480 T
cm 20 x 9,5 x 9,5
∅ V 1



∅ Ref. 2484
cm 20 x 12 x 13

∅ Ref. 2484 T
cm 20 x 12 x 12
∇ ⊗ RD 2484



≠D Ref. 2576
cm 9 x 7
≠D Ref. 2577
cm 10 x 8
≠D Ref. 2578
cm 12 x 9



≠D Ref. 2581
cm 10 x 8
≠D Ref. 2583
cm 12 x 9



≠O Ref. 2574
cm 23 x 9
♀ Ref. 2574 T
cm 23 x 9
♂ V 1



≠O Ref. 2575
cm 12 x 9
♀ Ref. 2575 T
cm 12 x 9
∇ ⊗ RD 61



≠ Ref. 2584
cm 41 x 16,5 x 1,5



♀ Ref. 2569 T
cm 31 x 18 x 9
∇ D 4 (6 Und.)
⊗ R 4 (2 Und.)



≠D Ref. 2572
cm 32 x 18 x 9
∇ D 4 (3 Und.)
⊗ R 4



∅ Ref. 2570
cm 21 x 11,5
♀ Ref. 2570 T
cm 21 x 11,5
⊗ ∇ RD 64



∅ Ref. 2570 I
cm 21 x 11,5 x 12
♀ Ref. 2568 I
cm 21 x 11,5
⊗ ∇ RD 64



∅ Ref. 2570 D
cm 21 x 11,5 x 12
♀ Ref. 2568 D
cm 21 x 11,5
⊗ ∇ RD 64



∅ Ref. 2571
cm 20 x 11,5 x 5,5
∇ D 63



∅ Ref. 2571 I
cm 20 x 11,5 x 6
∇ D 63



∅ Ref. 2571 D
cm 20 x 11,5 x 6
∇ D 63



∅ Ref. 2555
cm 18,5 x 10
⊗ ∇ RD 97



∅ Ref. 2556
cm 20 x 8
♀ Ref. 2556 T
cm 20 x 8
🔥 V 1



∅ Ref. 2565
cm 14 x 9
⊗ ∇ RD 96



♀ Ref. 2490
cm 15 x 9
📏 7,5 cm



∅ Ref. 1335
cm 24 x 15,5 x 8
∇ D 122
⊗ R 122



♀ Ref. 2555 B
cm 20 x 8
📏 7,5 cm
⊗ ∇ RD 97



♀ Ref. 2556 B
cm 22 x 8
📏 5,5cm
🔥 V 1



♀ Ref. 2565 B
cm 15 x 7
📏 5,5 cm
⊗ ∇ RD 96



∅ Ref. 2564
cm 12 x 7,5
♀ Ref. 2564 T
cm 12 x 7,5
∇ D 52



∅ Ref. 2566
cm 20 x 12,5
♀ Ref. 2566 T
cm 20 x 12,5
⊗ ∇ RD 59



♀ Ref. 2567 T
cm 30 x 19
∇ D 62
⊗ R 62



∅ Ref. 2557
cm 18,5 x 8
⊗ ∇ RD 97



∅ Ref. 2558
cm 18,5 x 8
⊗ ∇ RD 97



∅ Ref. 2559
cm 18,5 x 8
⊗ ∇ RD 97



∅ Ref. 1336 B
cm 20 x 12 x 10
7 cm
⊗ V RD 64



∅ Ref. 1336
cm 18 x 12
⊗ V RD 64



∅ Ref. 1770
cm 31 x 15 x 10
V D 10 (2 Und.)
⊗ R 10

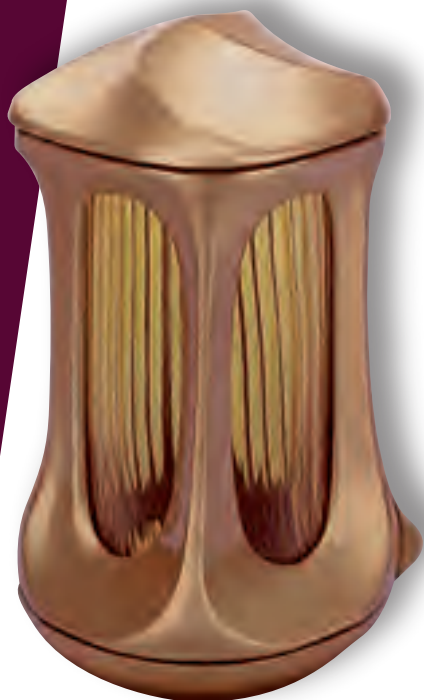

∅ Ref. 1775
cm 21 x 13
∅ Ref. 1775 T
cm 21 x 12
6 cm
V V 8



∅ Ref. 1780 B
cm 31 x 15 x 20
V D 10 (4 Und.)
⊗ R 10 (2 Und.)



≠ Ref. 2615
cm 43 x 25 x 5



≠ Ref. 545
cm 16 x 13 x 9
∇ D 120
⊗ R 120



≠ Ref. 1332
cm 18 x 15 x 7,5
∇ D 32
⊗ R 32



≠ Ref. 546
cm 20 x 13 x 10
∇ D 546



≠ Ref. 2527
cm 12 x 6,5 x 7
∇ 9



≠ Ref. 2526 ∅ Ref. 2526 B
cm 12,5 x 7 x 8,5 cm 14,5 x 7
∅ Ref. 2526 T ≡ 4,5 cm
cm 12,5 x 7 ∇ D 2526
∇ D 2526



≠ Ref. 2524
cm 12 x 6,5 x 7
∇ 9



≠ Ref. 2525 ∅ Ref. 2525 B
cm 12,5 x 7 x 8,5 cm 14,5 x 7
∅ Ref. 2525 T ≡ 4,5 cm
cm 12,5 x 7 ∇ D 2526
∇ D 2526



∅ Ref. 1372
cm 19 x 10,5 x 11
▽ D 1372



♀ Ref. 1372 B
cm 18 x 10,5
⊞ 5,5 cm
▽ D 1372



∅ Ref. 1370
cm 19 x 10 x 10,5
▽ D 200



♀ Ref. 1370 B
cm 20 x 10
⊞ 5 cm
▽ D 200



∅ Ref. 1376
cm 17 x 10 x 11
▽ D 202



∅ Ref. 1375
cm 17 x 10 x 11
▽ D 202



∅ Ref. 562
cm 19 x 7,3 x 4



∅ Ref. 560
cm 11 x 3,8 x 3

Sin depósito /
Without internal container

Sin depósito /
Without internal container



♀ Ref. 3190 B
cm 14 x 9,5
⊞ 5,5 cm
▽ V 3190



∅ Ref. 3190
cm 12,5 x 9,5 x 10
♀ Ref. 3190 T
cm 12,5 x 9,5
▽ V 3190



∅ Ref. 1377
cm 17 x 10
▽ V 3



∅ Ref. 2693
cm 19,5 x 8 x 9
♀ Ref. 2693 T
cm 19,5 x 8
⊗ √ RD 59



∅ Ref. 2696
cm 16 x 8
♀ Ref. 2696 T
cm 16 x 8
√ V 1



∅ Ref. 2692
cm 19,5 x 8 x 9
♀ Ref. 2692 T
cm 19,5 x 8
⊗ √ RD 59



∅ Ref. 2694
cm 19,5 x 8 x 9
♀ Ref. 2694 T
cm 19,5 x 8
⊗ √ RD 59



♀ Ref. 2562 T
cm 14 x 3,5
⊞ 3,5 cm
√ D 2562



∅ Ref. 2563
cm 10 x 3,5 x 5,5
√ D 2562
∅ Ref. 2562
cm 14 x 3,5 x 5,5
√ D 2562



∅ Ref. 2563 A
cm 10 x 3,5 x 5
√ D 2562
∅ Ref. 2562 A
cm 14 x 3,5 x 5
√ D 2562



♀ Ref. 1377 B
cm 16 x 8,5
⊞ 5,5 cm
√ V 3



♀ Ref. 2560 B
cm 12 x 5
⊞ 4,5 cm
√ D 52



∅ Ref. 2560
cm 11 x 5 x 6
√ D 52



∅ Ref. 1727
cm 18 x 8,5 x 10
♀ Ref. 1727 T
cm 18 x 8,5 x 9
√ D 60
⊗ R 60



⇒ Ref. 2710
cm 12 x 9
⇒ Ref. 2711
cm 15 x 11



⇒ Ref. 2713
cm 12 x 9
⇒ Ref. 2715
cm 15 x 11



⇒ Ref. 2718
cm 20 x 12 x 11,5
∇ ⊗ RD 89
♀ Ref. 2719 T
cm 29 x 16 x 13,5
∇ D 62
⊗ R 62



⇒ Ref. 2720
cm 20 x 6 x 6,5
♂ V 1



⇒ Ref. 2722
cm 18 x 17 x 11
♀ Ref. 2722 T
cm 18 x 17 x 10
∇ ⊗ RD 90



♀ Ref. 2585 R
cm 22,5 x 11,5
V 5
☀



⇒ Ref. 1050
cm 8 x 6
⇒ Ref. 1051
cm 9 x 7
⇒ Ref. 1052
cm 10 x 8
⇒ Ref. 1053
cm 12 x 9



⇒ Ref. 2585
cm 23,5 x 13,5
♀ Ref. 2585 T
cm 23,5 x 11,5
V 5



⇒ Ref. 2582
cm 19,5 x 9
♀ Ref. 2582 T
cm 19,5 x 9
V ⊗ RD 59



⇒ Ref. 2580
cm 12 x 7
♀ Ref. 2580 T
cm 12 x 7
V ⊗ RD 61



♀ Ref. 2582 B
cm 22 x 9
⊞ 5,5 x 4,5 cm
V ⊗ RD 59



♀ Ref. 2580 B
cm 15 x 7
⊞ 4,5 x 4,5 cm
V ⊗ RD 61



⇒ Ref. 1356
cm 22 x 11 x 11
∇ D 116
⊗ R 116



⇒ Ref. 1325
cm 19 x 14 x 8
∇ D 31
⊗ R 31



⇒ Ref. 1319
cm 15 x 6 x 5
∇ D 25



⇒ Ref. 1328
cm 18 x 12,5 x 8
∇ D 31
⊗ R 31



⇒ Ref. 1355
cm 28 x 14 x 10
∇ D 123
⊗ R 123



⇒ Ref. 1354
cm 25 x 16 x 8
∇ D 114
⊗ R 114



⇒ Ref. 1326
cm 20 x 13,5 x 10
∇ D 31
⊗ R 31



⇒ Ref. 1331
cm 22 x 13 x 10
∇ V 1



⇒ Ref. 1340
cm 40 x 15 x 9
∇ D 118
⊗ R 118



♀ Ref. 2665 T
cm 30 x 17 x 15,5
∇ D 69
⊗ R 69



♀ Ref. 2669 T
cm 27 x 15 x 13
□ V 2669



≡ Ref. 2645 I
cm 24 x 15 x 6
∇ D 2646



≡ Ref. 2646
cm 24 x 15 x 6
∇ D 2646
♀ Ref. 2641
cm 25 x 15 x 13
∇ D 2646 (2Und.)



≡ Ref. 2645 D
cm 24 x 15 x 6
∇ D 2646



⇒ Ref. 2725
cm 12 x 9
⇒ Ref. 2726
cm 15 x 11



⇒ Ref. 2728
cm 12 x 9
⇒ Ref. 2730
cm 15 x 11



⇒ Ref. 2733
cm 17,5 x 16,5 x 12,5
⇒ Ref. 2733 T
cm 17,5 x 16,5 x 12
V ⊗ RD 90



⇒ Ref. 2735
cm 20 x 8,5 x 9,5
⇒ Ref. 2735 T
cm 20 x 8,5 x 9,5
V 1



⇒ Ref. 2737
cm 19,5 x 10,5 x 11,5
⇒ Ref. 2737 T
cm 19,5 x 10,5 x 11
V ⊗ RD 89



⇒ Ref. 2630
cm 12 x 9
⇒ Ref. 2631
cm 15 x 11



⇒ Ref. 2633
cm 12 x 9
⇒ Ref. 2635
cm 15 x 11



⇒ Ref. 2587
cm 20 x 12 x 3
V ⊗ RD 89
♀ Ref. 2420T
cm 28,5 x 20 x 20
V D 62
⊗ R 62



⇒ Ref. 2588
cm 20 x 10 x 12
V 1



⇒ Ref. 2586
cm 18 x 19 x 15
V ⊗ RD 90



∅ Ref. 2530
cm 19 x 12 x 13
♀ Ref. 2530 T
cm 19 x 12
⊗ V RD 64



∅ Ref. 2531
cm 21 x 9 x 10
♀ Ref. 2531 T
cm 21 x 9
♂ V 1



∅ Ref. 2520
cm 20 x 12 x 13
♀ Ref. 2520 T
cm 20 x 12
∇ D 60
⊗ R 60



∅ Ref. 2522
cm 19 x 8,5 x 9,5
♀ Ref. 2522 T
cm 19,5 x 8,5
♂ V 1



♀ Ref. 1968 T
cm Ø 40
♂ 20 cm
∇ D 1968



♀ Ref. 1408 T
cm Ø 24,5 x 12,5
♂ 18 cm
∇ D 1405



♀ Ref. 1405 T
cm Ø 25 x 13
♂ 14 cm
∇ D 1405



♀ Ref. 2700
cm 100 x 56 x 13



♀ Ref. 2704
cm 24 x 12
♁ 9 cm
∇ D 62
⊗ R 62



♀ Ref. 2706
cm 21 x 12
♁ 9 cm
∇ V 5



♀ Ref. 2708
cm Ø 13 x 9
♁ 9 cm



♀ Ref. 2702
cm Ø 40 x 20
♁ 20 cm



⇒ Ref. 5580
cm 27 x 17 x 12
∨ D 31
⊗ R 31



⇒ Ref. 5581
cm 22 x 11,5 x 7
∨ V 1



⇒ Ref. 5583
↔ ↑ ∨
cm 28 x 32 x 9
∨ D 10
⊗ R 10



⇒ Ref. 5582
cm 42 x 27 x 7,5
∨ V 1



♀ Ref. 2598 T
 cm 28 x 16
 ☐ 11 cm
 ∇ D 2598
 ⊗ R 2598



♀ Ref. 2645 B
 cm 23 x 13
 ☐ 8 x 8 cm
 ☐ V 2644



∅ Ref. 2645
 cm 23 x 13 x 14
 ☐ V 2644



♀ Ref. 2597 T
 cm 25,5 x 10,5
 ☐ 7 cm
 ∅ Ref. 2597
 cm 25,5 x 11
 ∇ D 62
 ⊗ R 62



♀ Ref. 2644 B
 cm 28 x 13
 ☐ 8 x 8 cm
 ☐ V 2644



∅ Ref. 2644
 cm 28 x 13 x 14
 ☐ V 2644



Ref. 2666 B
cm 28 x 13
8 x 8 cm
V 2668



Ref. 2666
cm 28 x 13 x 14,5
V 2668



Ref. 2668 B
cm 33 x 13
8 x 8 cm
V 2668



Ref. 2668
cm 33 x 13 x 14,5
V 2668



♀ Ref. 2663 B
cm 39 x 16
☒ 12,5 x 12,5 cm
☐ V 2663



♂ Ref. 2663
cm 36 x 16 x 18
☐ V 2663



♀ Ref. 2664 R
cm 27,5 x 15,5
☒ 10,5 x 10,5 cm
☐ V 2663
☀



♀ Ref. 2676 B
cm 35 x 15,5
☒ 10,5 x 10,5 cm
☐ V 2663



♀ Ref. 2664 B
cm 27 x 15,5
☒ 10,5 x 10,5 cm
☐ V 2663



♀ Ref. 2640 B
cm 32 x 14
☐ 9,5 x 9,5 cm
☐ V 2649



♀ Ref. 2640 S
cm 27 x 14
☐ 9,5 x 9,5 cm
☐ V 2649



♀ Ref. 2651 B
cm 30 x 14
☐ 10 x 10 cm
☐ V 2649



♀ Ref. 2649 B
cm 22,5 x 14
☐ 10 x 10 cm
☐ V 2649



♂ Ref. 2651
cm 29 x 14 x 15
☐ V 2649



♂ Ref. 2649
cm 21,5 x 14 x 15
☐ V 2649



♀ Ref. 2663 R
cm 28 x 16
☞ 12,5 x 12,5 cm
☐ V 2663
☀



♀ Ref. 2649 R
cm 21,5 x 14
☞ 10 x 10 cm
☐ V 2649
☀



♀ Ref. 2663 S
cm 28,5 x 16
☞ 12,5 x 12,5 cm
☐ V 2663
☀



♀ Ref. 2666 S
cm 26,5 x 13
☞ 8 x 8 cm
☐ V 2666
☀



♀ Ref. 2644 R
cm 20 x 13
☞ 8 x 8 cm
☐ V 2644
☀



♀ Ref. 2666 R
cm 26 x 13
☞ 8 x 8 cm
☐ V 2666
☀



♀ Ref. 482
cm 21 x 12
☷ 9,8 cm
☐ V 462



♀ Ref. 480
cm 21 x 14,5
☷ Ø 11,5 cm
☐ V 460



♀ Ref. 2671 S
cm 29 x 11
☷ 11 cm
☐ V 2671



♂ Ref. 2671
cm 32 x 13,5
☐ V 2671



♀ Ref. 2671 B
cm 35 x 11
☷ 11 cm
☐ V 2671



⌘ Ref. 2008
cm 47 x 19 x 2,5
⌘ Ref. 2028
cm 80 x 24 x 2,5



⌘ Ref. 2000
cm 44 x 18 x 2
⌘ Ref. 2001
cm 78 x 28 x 2,5



⌘ Ref. 2613
cm 59 x 28 x 1



♀ Ref. 2609 B
cm 93 x 30 x 12
♂ 15 x 12 cm



♂ Ref. 2636
cm 40 x 21,5 x 2



♂ Ref. 2609
cm 80 x 30 x 3



♂ Ref. 2016
cm 51 x 27 x 1,8



♀ **Ref. 2617 B**
cm 75 x 32 x 12,5
☐ 12,5 x 12,5 cm



♣ **Ref. 2616**
cm 68 x 32 x 3



♀ **Ref. 2618 B**
cm 75 x 32 x 12,5
☐ 12,5 x 12,5 cm

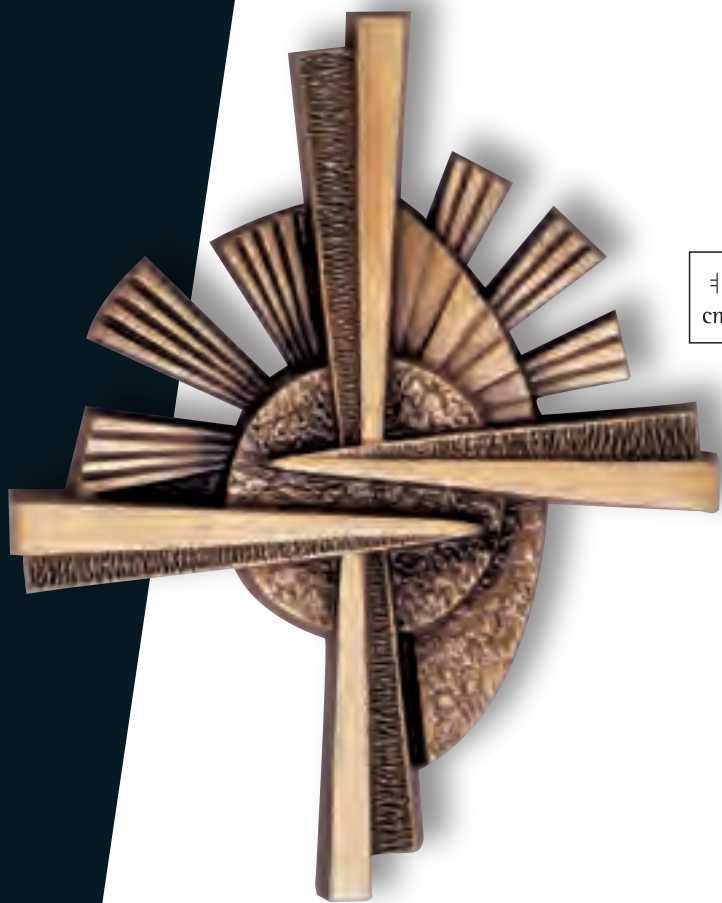

⌘ Ref. 2014
cm 32 x 27 x 3



⌘ Ref. 2610
cm 50 x 26 x 2,5



♀ Ref. 2610 B
cm 60 x 26
♂ 10,5 x 10,5 cm

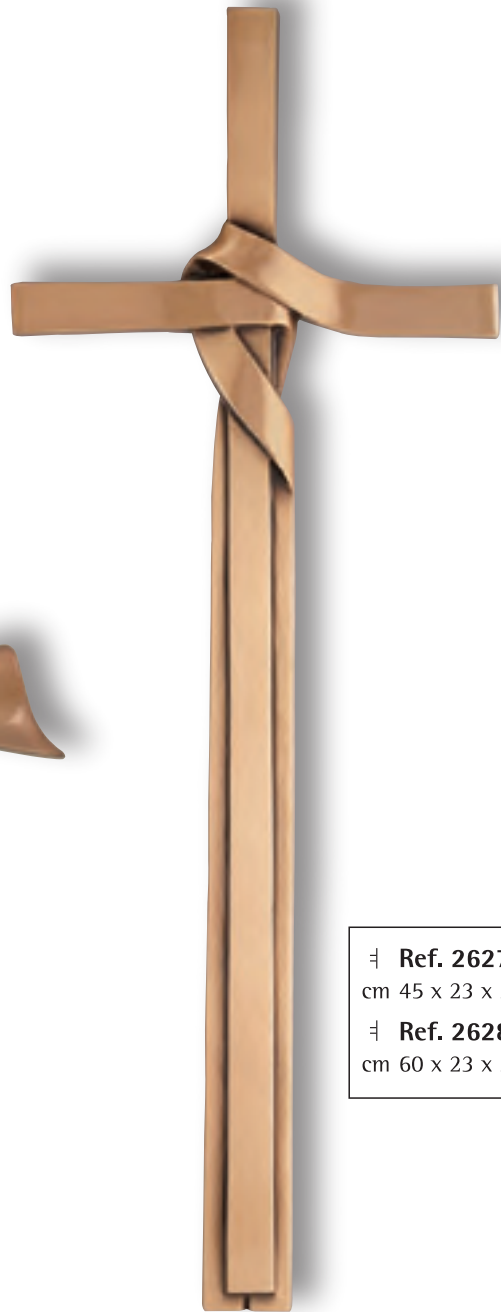

⌘ Ref. 2627
cm 45 x 23 x 2
⌘ Ref. 2628
cm 60 x 23 x 2

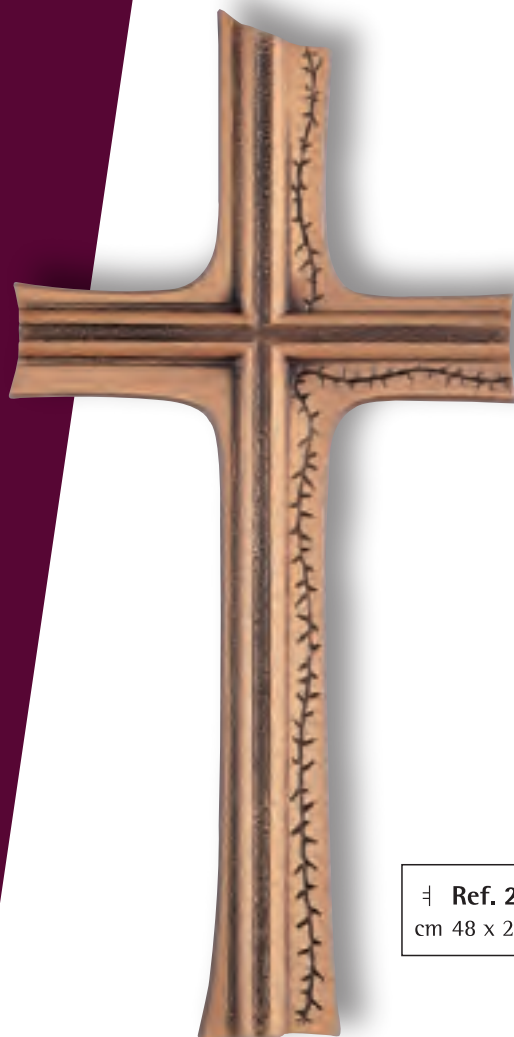

⌘ Ref. 2629
cm 48 x 24 x 2,2



⌘ Ref. 2012
cm 33 x 26 x 3



⌘ Ref. 2280
cm 40 x 16 x 1,5



⌘ Ref. 2626
cm 48 x 25 x 2



⌘ Ref. 2626 B
cm 54 x 24
12,5 cm

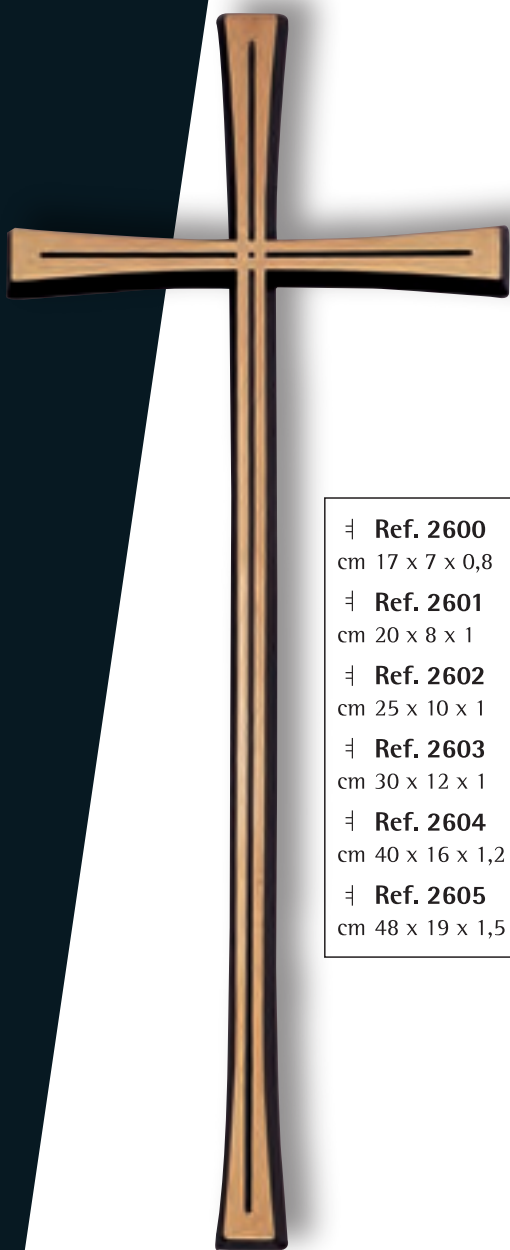

- ‡ Ref. 2600
cm 17 x 7 x 0,8
- ‡ Ref. 2601
cm 20 x 8 x 1
- ‡ Ref. 2602
cm 25 x 10 x 1
- ‡ Ref. 2603
cm 30 x 12 x 1
- ‡ Ref. 2604
cm 40 x 16 x 1,2
- ‡ Ref. 2605
cm 48 x 19 x 1,5



‡ Ref. 2278
cm 41 x 19 x 1

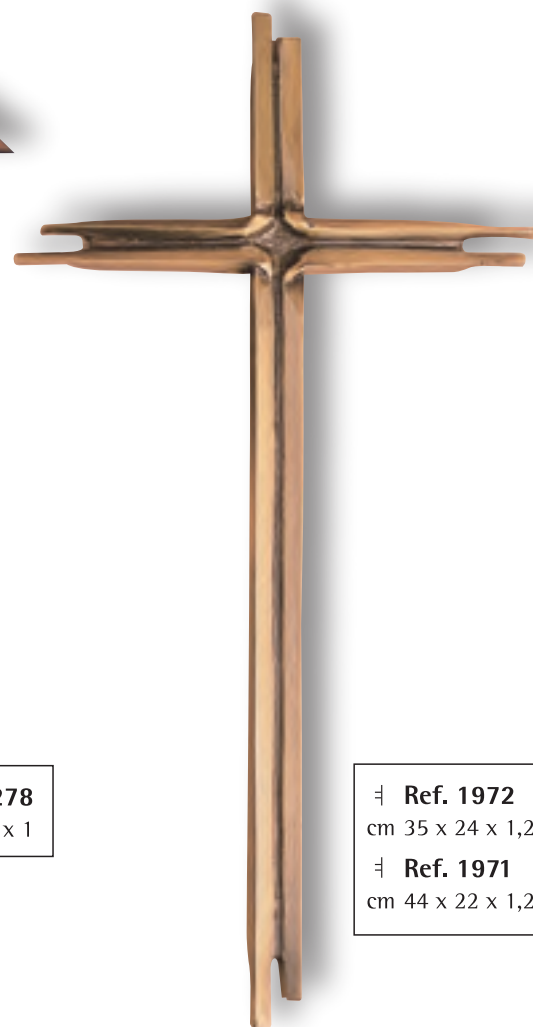

‡ Ref. 1972
cm 35 x 24 x 1,2

‡ Ref. 1971
cm 44 x 22 x 1,2



‡ Ref. 1457
cm 30 x 13 x 1



‡ Ref. 1458
cm 40 x 17 x 1



‡ Ref. 2619
cm 40 x 17 x 1



- 0,5 x 1 cm
- ‡ Ref. 2170 cm 20 x 5
- ‡ Ref. 2171 cm 25 x 6
- ‡ Ref. 2172 cm 30 x 8
- ‡ Ref. 2173 cm 35 x 10
- 1 x 2 cm
- ‡ Ref. 2175 cm 40 x 15
- ‡ Ref. 2176 cm 48 x 16
- 1,5 x 3 cm
- ‡ Ref. 2178 cm 80 x 25

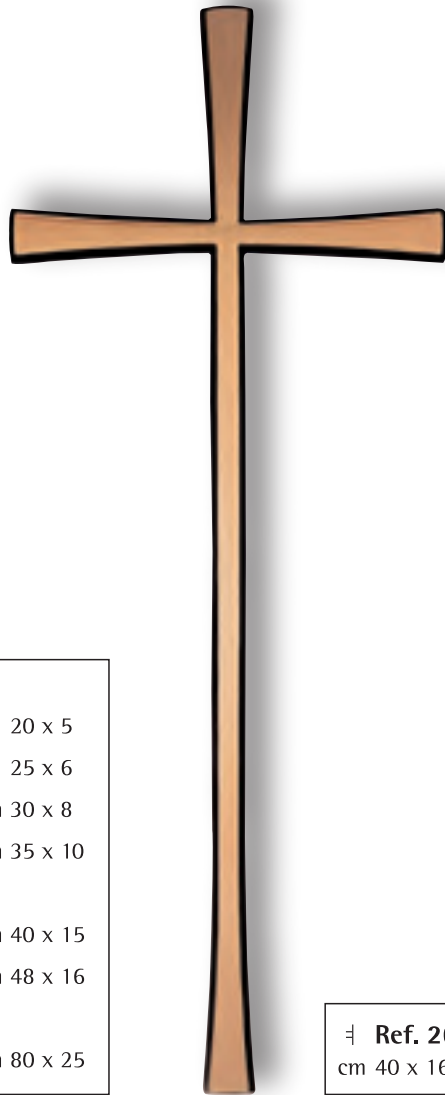

‡ Ref. 2606
cm 40 x 16 x 1



‡ Ref. 2017
cm 45 x 20 x 1



‡ Ref. 1615
cm 7 x 4 x 0,5

‡ Ref. 2410
cm 20 x 10 x 1

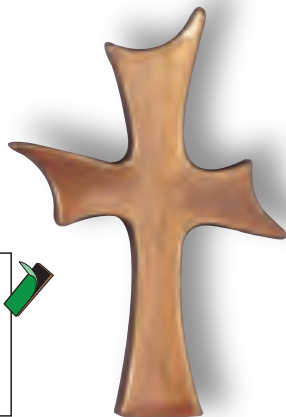

‡ Ref. 1612
cm 7 x 5 x 0,7

‡ Ref. 1596
cm 15 x 8 x 1

‡ Ref. 1597
cm 27 x 15 x 1



‡ Ref. 1910
cm 10 x 5,5 x 1



‡ Ref. 1911
cm 12,5 x 6 x 1



‡ Ref. 1914
cm 12 x 6,5 x 1



‡ Ref. 1915
cm 14,5 x 6 x 0,6



‡ Ref. 1916
cm 12 x 6,5 x 0,8



‡ Ref. 1912
cm 13 x 6,5 x 1,2



Ref. 2658
cm 40 x 16 x 2,5

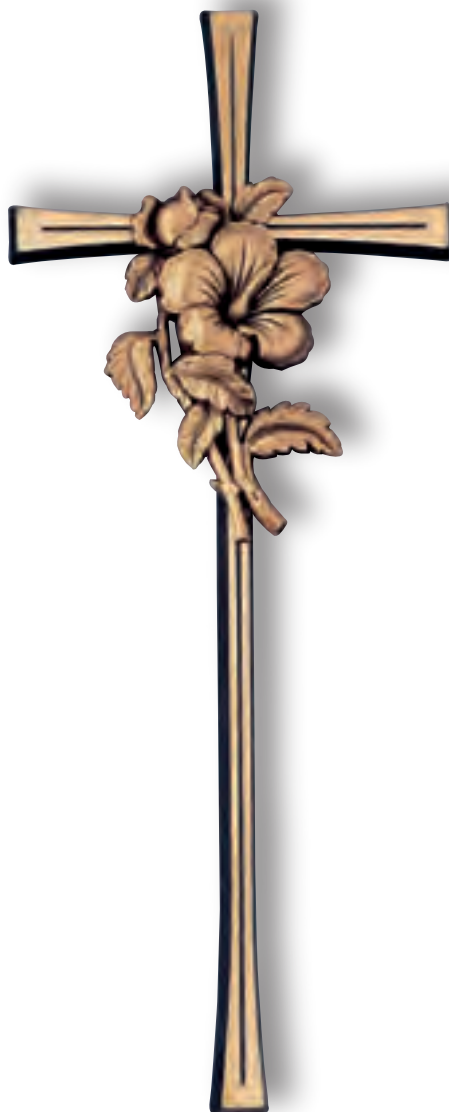

Ref. 2661
cm 48 x 19 x 2,5



Ref. 2659
cm 40 x 16 x 2



Ref. 2288
cm 40 x 16 x 3



Ref. 2409
cm 13,5 x 7,5 x 2



Ref. 2667
cm 40 x 16 x 3



Ref. 2654
cm 40 x 16 x 3



Ref. 2412
cm 20 x 10 x 2



Ref. 2662
cm 40 x 16 x 2,5



Ref. 2286
cm 40 x 16 x 2



Ref. 2323
cm 47 x 22 x 3



Ref. 2287
cm 40 x 16 x 3



✠ Ref. 2006
cm 48 x 24 x 7



✠ Ref. 2002
cm 48 x 24 x 6
✠ Ref. 2007
(sólo la cruz / only the cross)
cm 48 x 24 x 2



✠ Ref. 2011
cm 47 x 22 x 4



✠ Ref. 1456
cm 30 x 13 x 3



✠ Ref. 2411
cm 20 x 10 x 3



☩ **Ref. 2009**
cm 47 x 25 x 6

☩ **Ref. 5659**
(sólo Cristo / only Christ)
cm 33 x 22 x 5



☩ **Ref. 2325**
cm 47 x 22 x 5



☩ **Ref. 2005**
cm 46 x 25 x 5,5



☩ **Ref. 2622**
cm 25 x 10 x 2,5

☩ **Ref. 2623**
cm 30 x 12 x 2,5



☩ **Ref. 2620**
cm 17 x 7 x 1,5

☩ **Ref. 2621**
cm 20 x 8 x 1,5



☩ **Ref. 2624**
cm 40 x 16 x 3



† Ref. 2625
cm 48 x 19 x 5



† Ref. 2285
cm 40 x 16 x 3



† Ref. 2010
cm 45 x 20 x 4



Ejemplo 31
Example

† SATINADO FINISH
✠ ORO / GOLD FINISH



Ejemplo 32
Example

† SATINADO FINISH
✠ ORO / GOLD FINISH

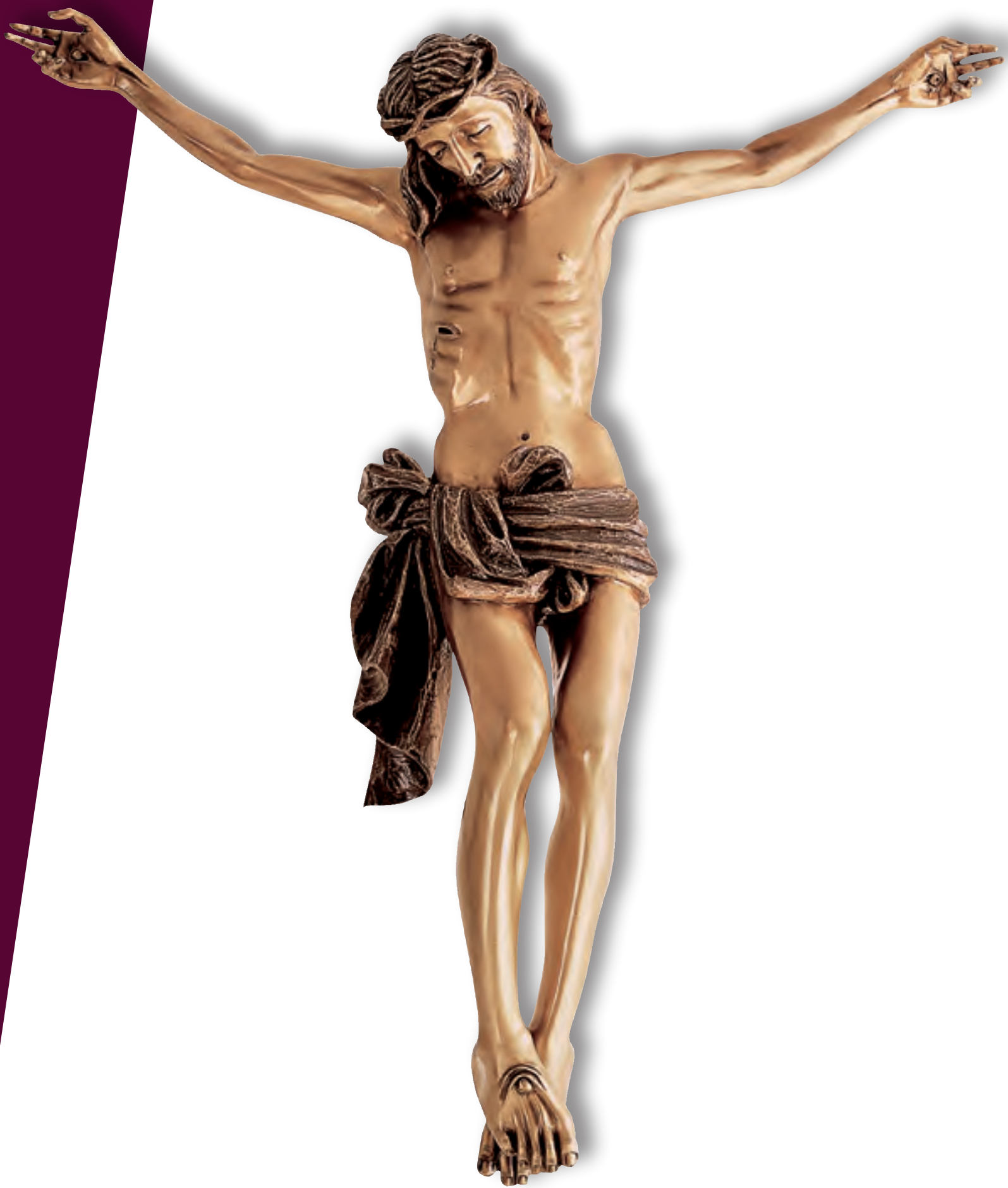

Ref. 5641
cm 134 x 116 x 30

CONSULTEN PRECIO Y PLAZO DE ENTREGA / ASK FOR PRICE AND DELIVERY TIME



⇒ Ref. 5638	⇒ Ref. 5638 E	corporeo, espalda completa Full back
* ⇒ Ref. 5638 M cm 88 x 66 x 14	* ⇒ Ref. 5638 EM cm 88 x 68 x 17	

* ACABADO NEGRO / BLACK FINISH



Ref. 5640
cm 85 x 78 x 23



⇒ Ref. 5637
⇒ Ref. 5637 C
* ⇒ Ref. 5637 M
cm 77 x 51 x 9

* ACABADO NEGRO / BLACK FINISH



Ref. 5634
cm 72 x 51 x 9



Ref. 5633
cm 71 x 54 x 9

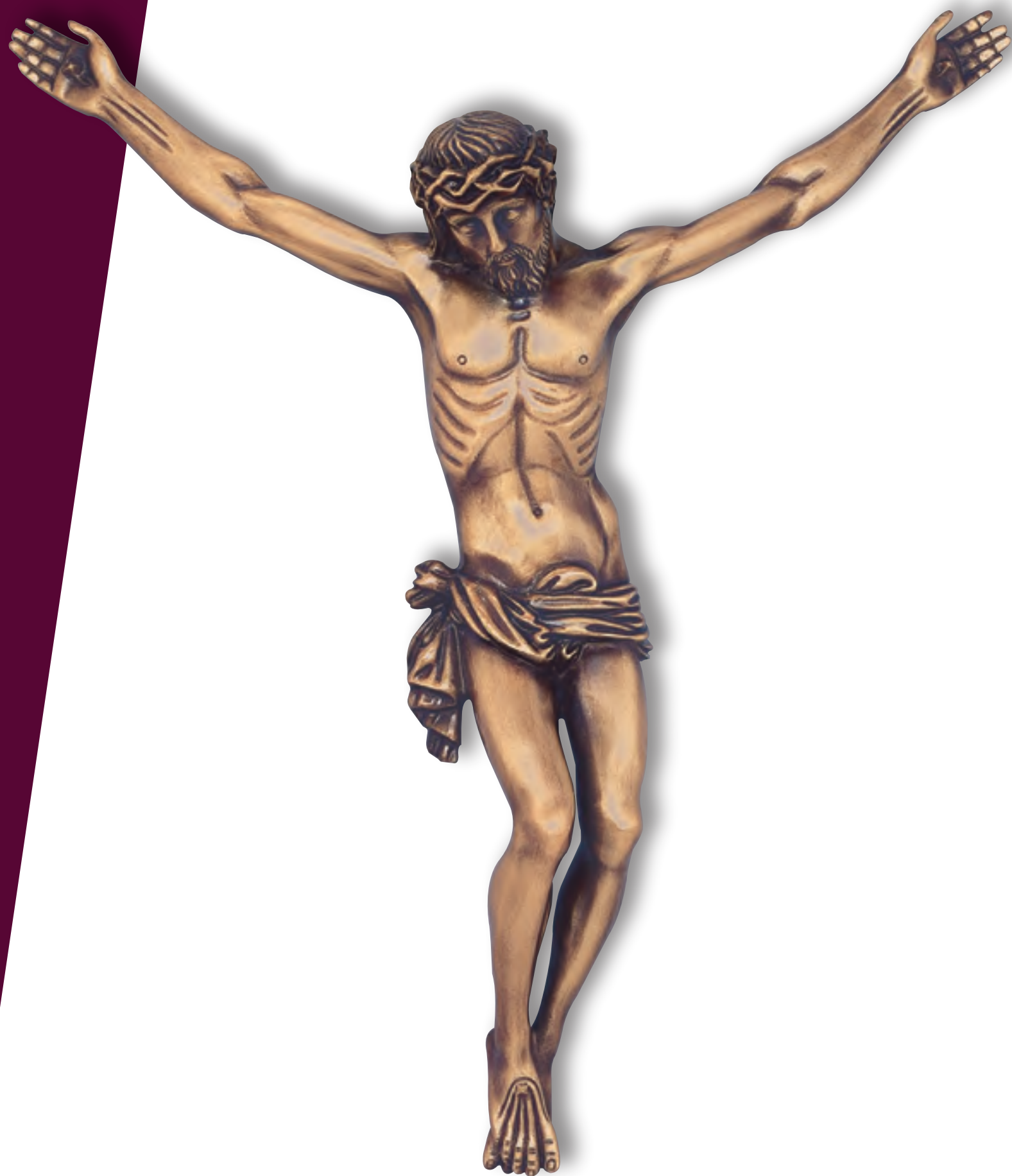

Ref. 5639
cm 68 x 59 x 15



⇒ Ref. 5636
⇒ Ref. 5636 C
cm 65 x 51 x 10



⇒ Ref. 5635

⇒ Ref. 5635 C

* ⇒ Ref. 5635 M

cm 60 x 52 x 7

* ACABADO NEGRO / BLACK FINISH



⇒ Ref. 5632
⇒ Ref. 5632 C
* ⇒ Ref. 5632 M
cm 54 x 37,5 x 7

* ACABADO NEGRO / BLACK FINISH



⇒ Ref. 5630
⇒ Ref. 5630 C
cm 42 x 32 x 6



⇒ Ref. 5650
⇒ Ref. 5650 C
cm 36 x 24 x 3,5

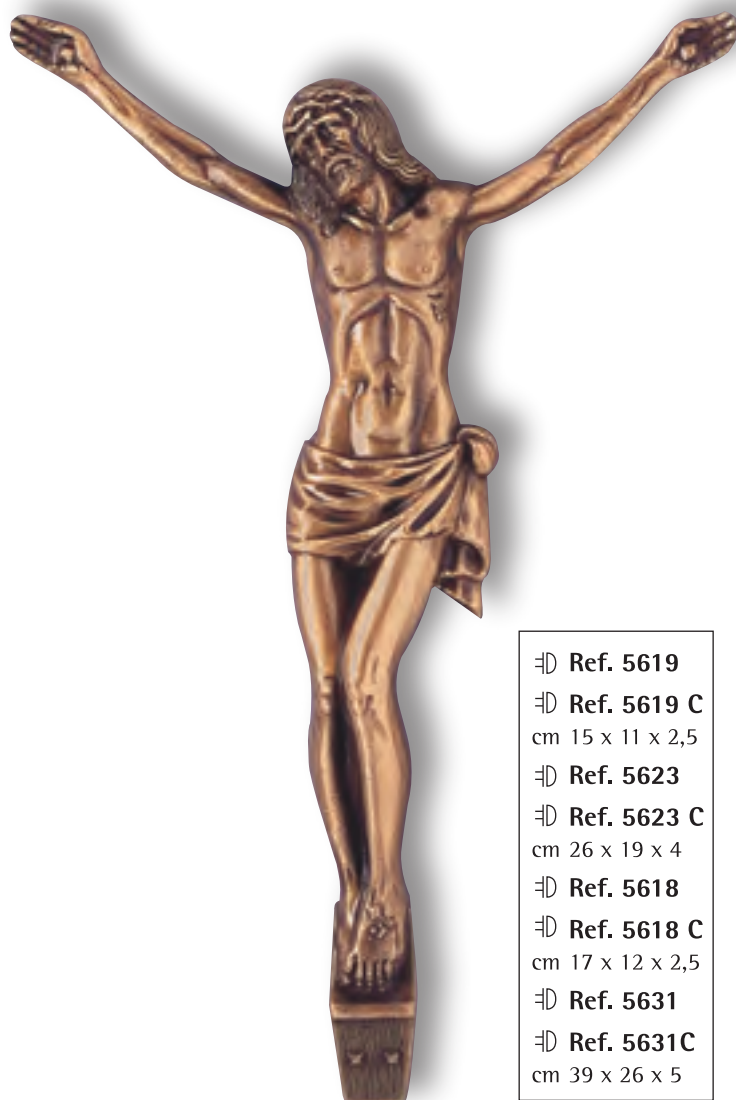

⇒ Ref. 5619
⇒ Ref. 5619 C
cm 15 x 11 x 2,5
⇒ Ref. 5623
⇒ Ref. 5623 C
cm 26 x 19 x 4
⇒ Ref. 5618
⇒ Ref. 5618 C
cm 17 x 12 x 2,5
⇒ Ref. 5631
⇒ Ref. 5631C
cm 39 x 26 x 5



⇒ Ref. 5626
⇒ Ref. 5626 C
cm 30 x 20 x 5



⇒ Ref. 5628
⇒ Ref. 5628 C
cm 35 x 20 x 4



⇒ Ref. 5629
 ⇒ Ref. 5629 C
 cm 29 x 24 x 4,5



⇒ Ref. 5616
 ⇒ Ref. 5616 C
 cm 23 x 16 x 2,2



⇒ Ref. 5617
 ⇒ Ref. 5617 C
 cm 20 x 17 x 4

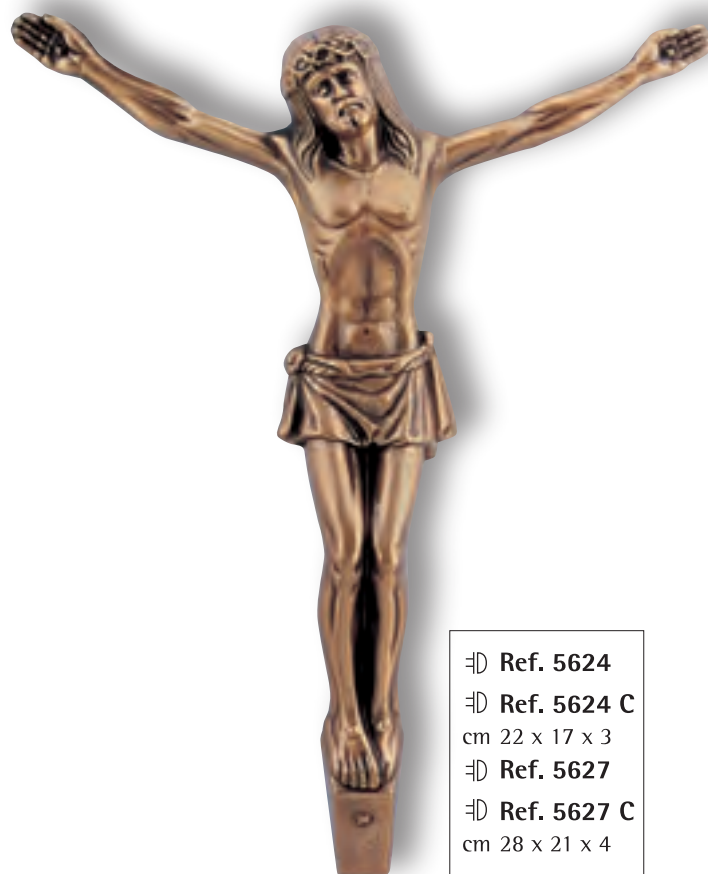

⇒ Ref. 5624
 ⇒ Ref. 5624 C
 cm 22 x 17 x 3
 ⇒ Ref. 5627
 ⇒ Ref. 5627 C
 cm 28 x 21 x 4



⇒ Ref. 5606
⇒ Ref. 5606 C
cm 16 x 15 x 3



⇒ Ref. 5644
cm 32 x 29 x 6



⇒ Ref. 5600
⇒ Ref. 5600 C
cm 25 x 17 x 6



⇒ Ref. 5620
cm 7 x 5,5 x 1



⇒ Ref. 5621
⇒ Ref. 5621 C
cm 10 x 8 x 1,5



Ref. 5584
cm 54 x 40 x 11



Ref. 5588
cm 46 x 29 x 10



⇒ Ref. 5585
cm 51 x 39 x 9,5



⇒ Ref. 5589
cm 44 x 29 x 8,5



Ref. 5587
cm 46 x 27 x 11



Ref. 5586
cm 53 x 27 x 12



Ref. 3155
cm 50 x 29 x 13



⇒ Ref. 5730
cm 57 x 37 x 8,5



⇒ Ref. 5112
cm 51 x 34 x 8



Ref. 5425
cm 52 x 45 x 9



Ref. 5410
cm 46 x 39 x 8



Ref. 5092
cm 39 x 35 x 6



Ref. 5411
cm 40 x 23 x 5

Ref. 5128
cm 34 x 34 x 5



Ref. 5126
cm 14 x 14 x 1,5



⇒ Ref. 2685
cm 30 x 22 x 5,5



⇒ Ref. 2681
↕ ↔ ↘
cm 12 x 11 x 3
⇒ Ref. 2682
cm 27 x 25 x 6



⇒ Ref. 3038
cm 24,5 x 17,5 x 6



⇒ Ref. 5476
cm 41 x 18 x 5



⇒ Ref. 3040
cm 22 x 17 x 6



⇒ Ref. 5114
cm 40 x 12 x 5



PIEDAD CON ÁNGEL

⇒ Ref. 5396
cm 34 x 29 x 8



ENTIERRO

⇒ Ref. 5334
cm 60 x 41 x 9



⇒ Ref. 5086
cm 47 x 26 x 7



⇒ Ref. 5098
cm 34 x 26 x 7



⇒ Ref. 5102
cm 31 x 26,5 x 5



⇒ Ref. 5094
cm 36 x 17 x 6



⇒ Ref. 1925 
cm 10 x 8 x 0,8



⇒ Ref. 5090
cm 36 x 23 x 7



⇒ Ref. 2657 
cm 12 x 7 x 1,5
⇒ Ref. 2660
cm 17 x 10 x 1,5



NAZARENO DEL GRAN PODER

Ref. 5420
cm 35 x 21 x 6



EL PASO

Ref. 4130
cm 55 x 43 x 7



NAZARENO

⇒ Ref. 5132
cm 34 x 28 x 7



CRISTO DE MEDINACELI

⇒ Ref. 5134
cm 32 x 9 x 7



NAZARENO DEL GRAN PODER

⇒ Ref. 5421
cm 36 x 22 x 7,5



⇒ Ref. 3004
cm 11,5 x 10,5 x 2
⇒ Ref. 3005
cm 24 x 22 x 6



⇒ Ref. 3009
cm 27 x 20,5 x 7



⇒ Ref. 3101
cm 22 x 19 x 5,5



⇒ Ref. 5156
cm 27 x 23 x 8



Ref. 3024
cm 31 x 22,5 x 10



Ref. 3016
cm 8 x 6 x 2
Ref. 3018
cm 18 x 14 x 4



Ref. 3003
cm 31 x 21 x 11



Ref. 5700
cm 33 x 26 x 15



⇒ Ref. 3007
cm 41 x 31 x 11



⇒ Ref. 3034
cm 21 x 20,5 x 7



⇒ Ref. 3030
cm 23,5 x 15,5 x 7



⇒ Ref. 3000
cm 36 x 34 x 10



⇒ Ref. 3032
cm 24 x 16,5 x 7



⇒ Ref. 3010
cm 27 x 19 x 7



⇒ Ref. 3012
cm 8 x 6 x 2
⇒ Ref. 3014
cm 18 x 14 x 4



⇒ Ref. 5012
cm 33 x 25 x 6



⇒ Ref. 5002
cm 27 x 24 x 6



⇒ Ref. 3022
cm 31 x 22,5 x 10



⇒ Ref. 5450
cm 37 x 29 x 8



⇒ Ref. 5168
cm 11,5 x 10,5 x 2



⇒ Ref. 3036
cm 21 x 20 x 7



⇒ Ref. 5572
cm 27 x 20 x 5,5



Ref. 5346
cm 37 x 17 x 7



Ref. 2650
cm 30 x 17 x 7



Ref. 2647
cm 12 x 7 x 1,5
Ref. 2648
cm 15 x 9 x 2



Ref. 5350
cm 29 x 14 x 3



Ref. 2652
cm 25 x 16 x 4



⇒ Ref. 3030
cm 23,5 x 15,5 x 7



⇒ Ref. 3032
cm 24 x 16,5 x 7



⇒ Ref. 3024
cm 31 x 22,5 x 10



⇒ Ref. 3022
cm 31 x 22,5 x 10



⇒ Ref. 3010
cm 27 x 19 x 7



⇒ Ref. 3009
cm 27 x 20,5 x 7



⇒ Ref. 5168
cm 11,5 x 10,5 x 2



⇒ Ref. 3004
cm 11,5 x 10,5 x 2



⇒ Ref. 3016
cm 8 x 6 x 2
⇒ Ref. 3018
cm 18 x 14 x 4



⇒ Ref. 3012
cm 8 x 6 x 2
⇒ Ref. 3014
cm 18 x 14 x 4



⇒ Ref. 2657
cm 12 x 7 x 1,5
⇒ Ref. 2660
cm 17 x 10 x 1,5



⇒ Ref. 2647
cm 12 x 7 x 1,5
⇒ Ref. 2648
cm 15 x 9 x 2



⇒ Ref. 3048
cm 20,5 x 9,5 x 5



⇒ Ref. 3044
cm 22,5 x 18 x 3



⇒ Ref. 3052
cm 21,5 x 11,5 x 3



⇒ Ref. 3054
cm 24 x 11 x 4,5



⇒ Ref. 3046
cm 21 x 12 x 3



⇒ Ref. 3050
cm 35,5 x 19,5 x 3



⇒ Ref. 3042
cm 27 x 18,5 x 3



VIRGEN DE LA CABEZA

⇒ Ref. 5728
cm 35 x 26 x 6



VIRGEN DE MONTSERRAT

⇒ Ref. 5296
cm 36 x 20 x 3



⇒ Ref. 5297
cm 30 x 20 x 4



VIRGEN DEL CARMEN

⇒ Ref. 5024
cm 38 x 17 x 7



VIRGEN DEL CARMEN

⇒ Ref. 5015
cm 25 x 9,5 x 2,5
⇒ Ref. 5016
cm 32 x 12 x 3
⇒ Ref. 5017
cm 34 x 14 x 3



VIRGEN DEL CARMEN

⇒ Ref. 5023
cm 36 x 21 x 8

VIRGEN DEL CARMEN

⇒ Ref. 5018
cm 34 x 20 x 4,5



VIRGEN DEL CARMEN

⇒ Ref. 5444
cm 36 x 29 x 10





VIRGEN DEL PILAR

Ref. 5033
cm 46 x 22 x 8,5



BUSTO VIRGEN DEL PILAR

Ref. 5299
cm 39 x 12 x 5,5



VIRGEN DE LOS DESAMPARADOS

Ref. 5029
cm 44 x 19 x 7



CORAZÓN DE MARÍA

⇒ Ref. 5028
cm 35 x 12 x 8



VIRGEN DEL ROSARIO

⇒ Ref. 5010
cm 37 x 14 x 8



INMACULADA

⇒ Ref. 5027
cm 40 x 16 x 4,5



VIRGEN DE FÁTIMA

⇒ Ref. 5109
cm 40,5 x 13,5 x 5



VIRGEN DE FÁTIMA

⇒ Ref. 5111
cm 44 x 13,5 x 5



NUESTRA SEÑORA DEL ROCÍO

⇒ Ref. 5424
cm 34 x 22 x 7



MARÍA AUXILIADORA

⇒ Ref. 5022
cm 34 x 14 x 7



ESPERANZA MACARENA

⇒ Ref. 5739
cm 30 x 17 x 5



PURÍSIMA

⇒ Ref. 5014
cm 35 x 16 x 7,5



VIRGEN DE GRACIA

⇒ Ref. 5711
cm 28 x 22 x 4



VIRGEN DE BEGOÑA

⇒ Ref. 5576
cm 24 x 12 x 6



SAN ANTONIO

⇒ Ref. 5078
cm 39 x 14 x 6



SAN ANTONIO ABAD

⇒ Ref. 5076
cm 37 x 17 x 7



SAN JUAN

⇒ Ref. 5068
cm 37 x 14,5 x 8



SAN JOSÉ

⇒ Ref. 5052
cm 36 x 14 x 7



SAN JOSÉ

⇒ Ref. 5051
cm 37 x 14 x 7



SAN JOAQUÍN

⇒ Ref. 5328
cm 36 x 14 x 6



SAN MIGUEL

⇒ Ref. 5340
cm 48 x 21 x 8



SAN JORGE

⇒ Ref. 5518
cm 40 x 27 x 6



SAN CRISTÓBAL

⇒ Ref. 5394
cm 38 x 15 x 7



SAN LUIS

⇒ Ref. 5070
cm 35 x 13 x 7



SAN VICENTE

⇒ Ref. 5066
cm 37 x 15 x 8



SAN RAMÓN

⇒ Ref. 5314
cm 34 x 15 x 7



SAN FRANCISCO

⇒ Ref. 5082
cm 39 x 23 x 6



SAN FRANCISCO

⇒ Ref. 5080
cm 36 x 11,5 x 7



SAN RAFAEL

Ref. 5062
cm 37 x 20 x 10



ORACIÓN DEL HUERTO

Ref. 5265
cm 43 x 29 x 4



SAGRADA FAMILIA

Ref. 5344
cm 37 x 24 x 8



⇒ Ref. 5200 I
cm 32,5 x 21 x 3,5



⇒ Ref. 5200 D
cm 32,5 x 21 x 3,5



⇒ Ref. 4605
cm 10 x 9 x 3



ÁNGEL DEL SILENCIO

⇒ Ref. 5044
cm 35 x 15 x 7,5



⇒ Ref. 4609
cm 10 x 5 x 2,5



ÁNGEL DE LA GUARDA

⇒ Ref. 5042
cm 40 x 21 x 10



⇒ Ref. 2058 I
cm 17 x 9,5 x 1,5



⇒ Ref. 2058 D
cm 17 x 9,5 x 1,5



⇒ Ref. 2056 
cm 13 x 9 x 2,5



⇒ Ref. 2049 I
cm 8 x 4 x 1



⇒ Ref. 2049 D
cm 8 x 4 x 1

⇒ Ref. 2050 I
cm 18 x 9 x 1

⇒ Ref. 2050 D
cm 18 x 9 x 1



⇒ Ref. 1931
↕ ↔ ↗
cm 14 x 12 x 6



⇒ Ref. 2044 I
cm 7,5 x 7,5 x 1



⇒ Ref. 2045 I
cm 9 x 8 x 1

⇒ Ref. 2046 I
cm 14 x 10 x 1,5

⇒ Ref. 2047 I
cm 20 x 16 x 2

⇒ Ref. 2044 D
cm 7,5 x 7,5 x 1

⇒ Ref. 2045 D
cm 9 x 8 x 1

⇒ Ref. 2046 D
cm 14 x 10 x 1,5

⇒ Ref. 2047 D
cm 20 x 16 x 2



⇒ Ref. 1920 
cm 8,5 x 7,5 x 1,2



⇒ Ref. 2048 I
cm 9 x 9 x 2



⇒ Ref. 2048 D
cm 9 x 6,5 x 2



⇒ Ref. 1932 
cm 15 x 8 x 1,5

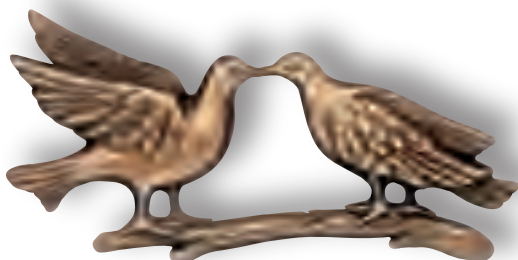

⇒ Ref. 2048
cm 18 x 9 x 2



⇒ Ref. 3008
cm 25 x 28 x 2

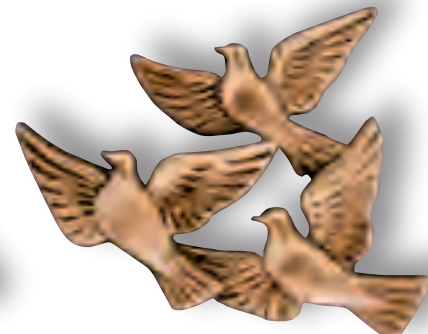

⇒ Ref. 1934 
cm 15 x 13 x 1



Ref. 1556 DB
cm 21 x 10 x 5,5



Ref. 1554 DB
cm 22 x 17 x 5,6



Ref. 1553 DB
cm 20 x 10 x 4



Ref. 1557 DB
cm 40 x 21 x 5



Ref. 1558 DB
cm 22 x 12 x 4,5



Ref. 1555 DB
cm 21 x 10 x 5,3



∅ Ref. 1996 IDR
cm 34 x 27 x 5



∅ Ref. 1552 DR
cm 16 x 8 x 5



∅ Ref. 1550 DR
cm 26 x 10 x 4,8



∅ Ref. 1551 DR
cm 44 x 18 x 7



∅ Ref. 1996 DDR
cm 34 x 27 x 5



∅ Ref. 1994
cm 46 x 15 x 5



∅ Ref. 1993
cm 37 x 14 x 5



∅ Ref. 1995
cm 48 x 20 x 5



∅ Ref. 1996
cm 18 x 12 x 5



∅ Ref. 1992
cm 28 x 14 x 5



∅ Ref. 1996 I
cm 34 x 27 x 5

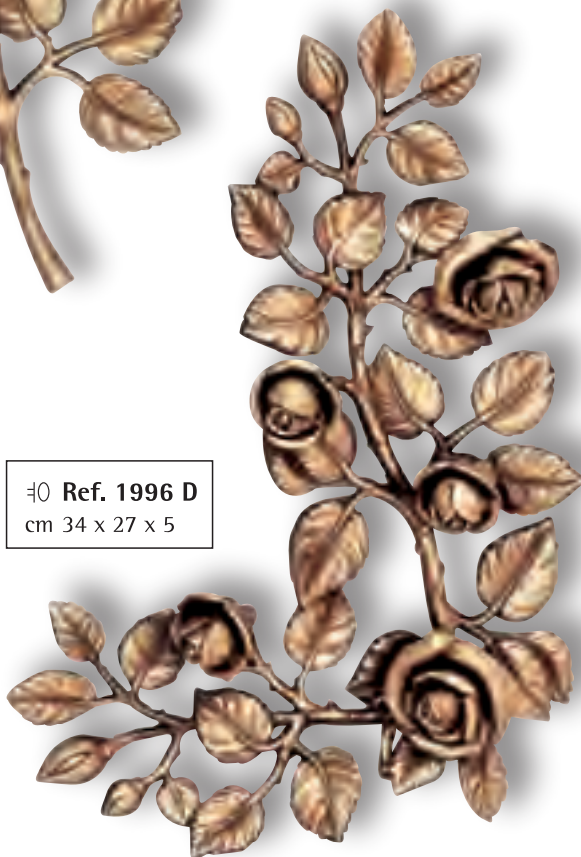

∅ Ref. 1996 D
cm 34 x 27 x 5

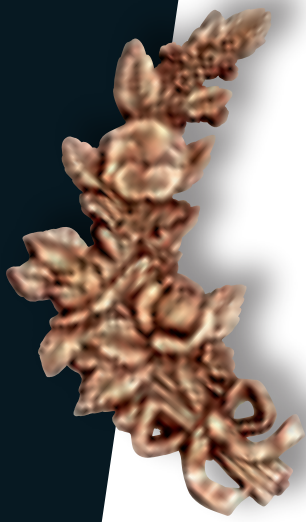

⇒ Ref. 1990 I
cm 21,5 x 12,5 x 1,5
⇒ Ref. 1989 I
cm 25 x 15 x 2

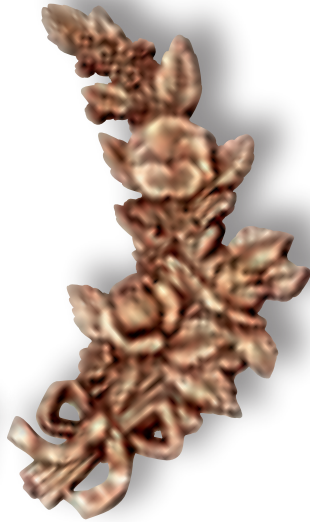

⇒ Ref. 1989 D
cm 25 x 15 x 2



⇒ Ref. 2460 I
cm 22 x 16 x 2



⇒ Ref. 2460 D
cm 22 x 16 x 2



⇒ Ref. 1987 I
cm 18 x 13 x 2



⇒ Ref. 1987 D
cm 18 x 13 x 2



⇒ Ref. 1508 I
cm 6 x 3 x 0,5
⇒ Ref. 1510 I
cm 12 x 4 x 1



⇒ Ref. 1508 D
cm 6 x 3 x 0,5
⇒ Ref. 1510 D
cm 12 x 4 x 1



⇒ Ref. 1990
cm 13 x 9 x 1,5



⇒ Ref. 1984
cm 18 x 8 x 2



⇒ Ref. 1347
cm 18 x 5 x 1



⇒ Ref. 1959
cm 25 x 9 x 2



⇒ Ref. 1955
cm 21 x 6 x 1



⇒ Ref. 1957
cm 23 x 6 x 1



⇒ Ref. 1986
cm 13 x 8 x 1
⇒ Ref. 1985
cm 19 x 10 x 1,5



⇒ Ref. 1901 I
cm 5 x 3,6 x 1
⇒ Ref. 1900 I
cm 10,5 x 7,5 x 1,5
⇒ Ref. 1902 I
cm 15 x 10 x 1,2



⇒ Ref. 1901 D
cm 5 x 3,6 x 1
⇒ Ref. 1900 D
cm 10,5 x 7,5 x 1,5
⇒ Ref. 1902 D
cm 15 x 10 x 1,2



⇒ Ref. 1341
cm 6 x 5 x 1,5
⇒ Ref. 1350
cm 10 x 6 x 2



⇒ Ref. 1349
cm 9,5 x 7 x 1,5

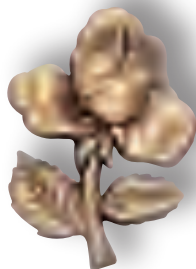

⇒ Ref. 1345
cm 9 x 7 x 2



⇒ Ref. 1998
cm 12,5 x 7,5 x 1,5



⇒ Ref. 1997
cm 12,5 x 10,5 x 1,5

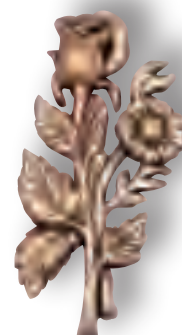

⇒ Ref. 1991
cm 13 x 7 x 1



⇒ Ref. 1343
cm 15 x 8 x 3



⇒ Ref. 1342
cm 15 x 8 x 4,5

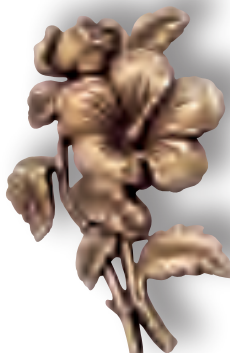

⇒ Ref. 1344
cm 15 x 10 x 1,5



⇒ Ref. 1346
cm 10,5 x 10 x 1



⇒ Ref. 1988
cm 14 x 8 x 1



⇒ Ref. 1958
cm 13,5 x 6 x 1

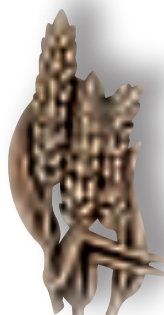

⇒ Ref. 1956
cm 13 x 7 x 1



⇒ Ref. 1937
cm 13 x 12 x 1,5

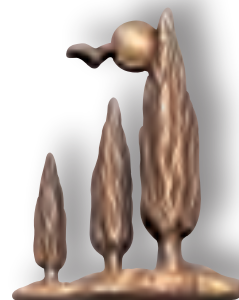

⇒ Ref. 1982
cm 12 x 10 x 2



⇒ Ref. 1940
cm 14 x 11 x 1,7



⇒ Ref. 1936
cm 19,5 x 13,5 x 0,8



⇒ Ref. 1983
cm 18 x 14 x 1,5



⇒ Ref. 1980
cm 18 x 17 x 2



⇒ Ref. 1977
cm 16 x 13 x 0,8



⇒ Ref. 1918
cm 20 x 11 x 1



⇒ Ref. 1951
cm 12,5 x 7,5 x 1,5



⇒ Ref. 1978
cm 17 x 15 x 2



⇒ Ref. 1953
cm 14 x 12 x 2



⇒ Ref. 1919
cm 15 x 12 x 1,5



⇒ Ref. 1979
cm 13 x 13 x 2



⇒ Ref. 1845
cm 16 x 10,5 x 1



⇒ Ref. 1949
cm 14 x 12 x 1,5



⇒ Ref. 1922
cm 15 x 12,5 x 1,8



⇒ Ref. 1946
cm 12,5 x 6,5 x 1,5



⇒ Ref. 1948
cm 14 x 12 x 1,5



⇒ Ref. 1952
cm 14 x 12 x 1,5



⇒ Ref. 1938
cm 16 x 14 x 2



⇒ Ref. 1950
cm 11,5 x 9 x 1



⇒ Ref. 1945
cm 12,5 x 7,5 x 1,2



⇒ Ref. 1954
cm 18 x 11 x 1



⇒ Ref. 1928
cm 10 x 10 x 1



⇒ Ref. 1865
cm 10 x 9 x 0,5



⇒ Ref. 1930
cm 12 x 10,5 x 1,5



⇒ Ref. 1917
cm 16 x 5 x 1



⇒ Ref. 1820
cm 18 x 10 x 1,5



⇒ Ref. 1846
cm 14 x 10 x 1



⇒ Ref. 1824
cm 12 x 7 x 1



⇒ Ref. 1935
cm 15 x 12 x 1,5



⇒ Ref. 1840
cm 10 x 7 x 1



⇒ Ref. 1924
cm 12 x 9 x 0,8



⇒ Ref. 1923
cm 16 x 6 x 0,5



⇒ Ref. 1939
cm 13 x 10 x 1



⇒ Ref. 1844
cm 14 x 5 x 0,8



⇒ Ref. 1848
cm 13,5 x 6,5 x 0,8



⇒ Ref. 1849
cm 16 x 12 x 0,5



⇒ Ref. 1358
cm 8 x 2,7 x 0,5

estatuas de bronce

bronze statues

La fundición artesanal de nuestras estatuas y el cuidado que ponemos en su acabado nos permite afirmar que el propietario de cualquiera de nuestras obras estará plenamente satisfecho de su adquisición. Como fundidores atendemos y orientamos a quienes estén interesados en la ejecución de esculturas singulares o trabajos especiales.

A fundição artesanal das nossas estatuas e o seu acabamento perfeito permite assegurar ao proprietário de qualquer uma das nossas obras a sua plena satisfação. Enquanto profissionais na área da fundição, estamos receptivos e apoiamos projetos para execução de esculturas singulares ou trabalhos especiais.

La fusione artigianale delle nostre statue e la cura che prendiamo della rifinitura, ci permette affermare che il proprietario di qualsiasi delle nostre opere, sarà completamente soddisfatto con la sua acquisizione. Come fonditori, noi abbiamo cura di cui che è interessato nell'esecuzione delle sculture singolari o degli lavori speciali.

The high quality of our production based upon years and exacting standards assures the owner of complete satisfaction. As one of the finest art foundries in the world we welcome the opportunity to work with customers on special projects of a kind sculptures for any requirement that you may have.

La fonte artisanale de nos statues et sa parfaite finition nous permet affirmer que le propriétaire de quiconque de nos oeuvres sera pleinement satisfait de son acquisition. Comme fondeurs, nous nous occupons et orientons ceux qui sont intéressés à l'exécution de sculptures singulières ou travaux spéciaux.

Wij kunnen de toekomstige eigenaar van onze werken verzekeren dat hij helemaal tevreden zal zijn van zijn aankoop en dit dankzij het kwaliteitsmateriaal van onze beelden en zijn perfecte afwerking. Als fabrikant leiden wij mensen op die geïnteresseerd zijn in het vervaardigen van eenvoudige en speciale beeldhouwwerken.



PIEDAD DE MIGUEL ANGEL

♀ Ref. 5100
cm 69 x 50 x 28
♂ 48 x 24 cm

♀ Ref. 5423
cm 19 x 15 x 7,5
♂ 14,5 x 7 cm



♀ **Ref. 3252**
↓ ↔ ↘
cm 132 x 117 x 55
☐ 117 x 53,5 cm

♀ **Ref. 3251**
↓ ↔ ↘
cm 78,5 x 71 x 39,5
☐ 71 x 39,5 cm

también sin base rectangular
also without rectangular base
↓ ↔ ↘
cm 75 x 68 x 37
☐ 68 x 37 cm



♀ Ref. 5908
cm 177 x 79 x 67
♂ 42 x 35 cm



♀ Ref. 5902
cm 95 x 50 x 31
♂ 21 x 20 cm



♀ Ref. 5900
cm 102 x 55 x 31
♂ 40 x 25 cm

♀ Ref. 5800
cm 51 x 53 x 47
↔ ↓
☐ 53 x 39 cm



♀ Ref. 5802
cm 52 x 46 x 48
↔ ↓
☐ 37,5 x 46,5 cm



♀ Ref. 5906
cm 58 x 29 x 27
☐ 13 x 19 cm



♀ Ref. 5903
cm 49 x 33 x 27
♂ 15 x 13 cm



♀ Ref. 5277
cm 79 x 34 x 22
♂ 32 x 19,5 cm





♀ Ref. 4350 I
cm 25 x 13 x 17,5
♂ 17,5 x 10 cm



♀ Ref. 4350 D
cm 25 x 13 x 17,5
♂ 17,5 x 10 cm



♀ Ref. 5545 I
cm 27 x 13 x 14
♂ 10 x 14 cm



♀ Ref. 5545 D
cm 27 x 13 x 14
♂ 10 x 14 cm



♀ Ref. 5418
cm 72 x 69 x 20
♂ 51 x 15



♀ Ref. 5590
↕ ↔ ♀
cm 69 x 33 x 41
☞ 33 x 40 cm



♀ Ref. 5596
con paloma / with dove
♀ Ref. 5598 *
con mariposa / with butterfly
↕ ↔ ♀
cm 69 x 33 x 41
☞ 33 x 40 cm

*CON MARIPOSA
*WITH BUTTERFLY



♀ Ref. 5595
cm 148 x 40 x 75
↔
♂ 35 x 51 cm



♀ **Ref. 3258 ***
 cm 180 x 72 x 20
 ⬜ 60 x 60

*CONSULTEN PRECIO Y PLAZO DE ENTREGA
 *ASK FOR PRICE AND DELIVERY TIME



♀ **Ref. 5597**
 ↓ ↔ ↘
 cm 44 x 18 x 13
 ↔ ↘
 ⬜ 15 x 13 cm

♀ **Ref. 5591**
 ↓ ↔ ↘
 cm 71 x 31 x 20
 ↔ ↘
 ⬜ 21 x 20 cm



♀ Ref. 5061
↑ ↓ ↘
cm 41 x 18 x 31
☞ 18 x 31 cm



♀ Ref. 5472
cm 49 x 23,5 x 43
↔ ↘
☞ 23,5 x 30 cm



♀ Ref. 5060
↑ ↓ ↔ ↘
cm 45 x 23 x 37,5
☞ 23 x 37,5 cm



♀ Ref. 5474
cm 75 x 21 x 46
↔ ↘
☞ 18 x 30 cm



INMACULADA

♀ Ref. 3220
cm 35 x 14 x 9
☐ 7 x 7 cm

♀ Ref. 3221
cm 40 x 15 x 8
☐ 8 x 7,5 cm

♀ Ref. 3222
cm 65 x 25 x 18
☐ 13 x 13 cm

♀ Ref. 3223
cm 82 x 32 x 21
☐ 16 x 16 cm



♀ Ref. 5113
cm 65 x 16 x 11
☐ 9,5 x 9 cm



VIRGEN NIÑA

♀ Ref. 3202
cm 65 x 14,5 x 11
☐ 12,5 x 11 cm



INMACULADA

♀ Ref. 3227
cm 61,5 x 24,5 x 21,5
♂ 17 x 17 cm

♀ Ref. 3228
cm 83 x 34,5 x 29
♂ 23 x 24 cm



INMACULADA

♀ Ref. 3224
cm 120 x 46 x 30
♂ 28 x 28 cm



VIRGEN DE FÁTIMA

♀ Ref. 5116
cm 60 x 20 x 16
☐ 13,5 x 13,5 cm



VIRGEN DE FÁTIMA

♀ Ref. 5118
cm 68 x 20 x 16
☐ 13,5 x 13,5 cm



♀ Ref. 5041
cm 64 x 34 x 20
♂ 23 x 22 cm



VIRGEN DE GUADALUPE

♀ Ref. 3205
cm 80 x 31 x 18
♂ 16 x 15,5 cm



STA. BERNARDETTE

♀ Ref. 5074
↑ ↓ ← → ↗
cm 35 x 12 x 18
☐ 12 x 18 cm



VIRGEN DE LOURDES

♀ Ref. 3198
cm 50 x 15 x 12,5
☐ 12 x 12 cm

♀ Ref. 3199
cm 75 x 23 x 20
☐ 17,5 x 16,5 cm



VIRGEN DE LOURDES

♀ Ref. 3194
cm 61 x 18,5 x 16,5
♂ 15 x 15,5 cm
♀ Ref. 3195
cm 82 x 25 x 22,5
♂ 21 x 22 cm



VIRGEN DE LOURDES

♀ Ref. 3197
cm 40 x 11 x 10
♂ 10 x 10 cm



VIRGEN DEL CARMEN

♀ Ref. 5031
cm 78x 27 x 22
☞ 20 cm



VIRGEN DEL CARMEN

♀ Ref. 5036
cm 80 x 28 x 22
☞ Ø 20 cm



VIRGEN DEL CARMEN

♀ Ref. 5648
cm 23 x 7 x 5
♂ 5,3 x 5 cm



VIRGEN DEL CARMEN

♀ Ref. 5649
cm 50 x 15 x 12
♂ 13 x 13 cm



VIRGEN DEL CARMEN

♀ Ref. 5038
cm 64 x 24 x 20
♂ 17 x 17 cm
♀ Ref. 5034
cm 84 x 33 x 27
♂ 23 x 23 cm



VIRGEN DEL CARMEN

♀ Ref. 5039
cm 68,5 x 25 x 19
♂ 17,5 x 17 cm



♀ Ref. 5037
cm 76 x 28 x 22
♂ Ø 20 cm



♂ Ref. 5594
↑ ↓ ← →
cm 97 x 71 x 53
☞ ☜ 43 x 53 cm



♂ Ref. 5170
↑ ↓ ← →
cm 92 x 29 x 25,5
☞ ☜ 27 x 25,5 cm



♀ Ref. 5158
 ♀ Ref. 5159 sin corazón/ without heart
 ↓ ↔ ↘
 cm 140 x 72 x 48
 ☐ 31 x 44 cm



♀ Ref. 5151 cm 35 x 11 x 8 ☐ 9 x 8 cm	♀ Ref. 5155 cm 50 x 16 x 11,5 ☐ 13 x 11,5 cm	♀ Ref. 5154 cm 81 x 25 x 18 ☐ 21 x 18 cm
♀ Ref. 5152 cm 40 x 13 x 9 ☐ 10,5 x 9 cm	♀ Ref. 5153 cm 65 x 21 x 15 ☐ 17 x 14,5 cm	



♀ Ref. 5164
cm 60 x 21 x 20,5
♂ 16 x 16 cm
♀ Ref. 5165
cm 81 x 32 x 32
♂ 23,5 x 24 cm



♀ Ref. 5160 ♀ Ref. 5162
cm 40 x 19 x 11 cm 82 x 41 x 30
♂ Ø 10 cm ♂ Ø 20 cm
♀ Ref. 5161
cm 61 x 29 x 21
♂ Ø 15 cm



♀ Ref. 5105
cm 43 x 34 x 26,5
♂ 19 x 17 cm



♀ Ref. 5593
cm 44 x 41 x 25
♂ 19 x 13,5 cm



♀ Ref. 3248
↔ ↑ ♀
cm 88 x 79 x 60



♀ Ref. 5592
↑ ↔ ♀
cm 53 x 24 x 30
♂ 24 x 30 cm



SAN ANTONIO

♀ Ref. 5239 *
cm 175 x 65 x 60
♂ 50 x 50 cm



SAN ANTONIO

♀ Ref. 5235
cm 60 x 21 x 19
♂ 17,5 x 17,5 cm



SAN ANTONIO

♀ Ref. 5236
cm 80 x 29 x 26
♂ 24 x 20 cm

*CONSULTEN PRECIO Y PLAZO DE ENTREGA
*ASK FOR PRICE AND DELIVERY TIME



SAN JOSÉ

♀ Ref. 5123
cm 80 x 28 x 17
♂ 20 x 20 cm



SAN PATRICIO

♀ Ref. 4960
cm 60 x 22 x 22,5
♂ 18 x 22 cm



SAN JOSÉ

♀ Ref. 5122
cm 60 x 21 x 18
♂ 17 x 17 cm



SAN PADRE PÍO

♀ Ref. 5240
 cm 60 x 21 x 17
 ♂ 18 x 15,5 cm

PAPA JUAN PABLO II

♀ Ref. 5950
 cm 30 x 10,5 x 12
 ♂ 9,5 x 9,5 cm
 ♀ Ref. 5951
 cm 67 x 24 x 28
 ♂ 20 x 20 cm
 ♀ Ref. 5952 *
 cm 220 x 70 x 84
 ↔ ↕
 ♂ 61 x 63 cm



*CONSULTEN PRECIO Y PLAZO DE ENTREGA
 *ASK FOR PRICE AND DELIVERY TIME



♀ Ref. 1970
cm 45 x 35 x 18



♀ Ref. 4502
cm 16 x 21 x 11



♀ Ref. 4504
cm 16 x 21 x 11



♀ Ref. 1975
cm 11 x 11 x 11



♀ Ref. 1976
cm 13 x 13 x 15



♀ Ref. 5108 *
cm 120 x 18 x 18

*CONSULTEN PRECIO Y PLAZO DE ENTREGA
*ASK FOR PRICE AND DELIVERY TIME

♀ Ref. 1969
cm 64 x 46 x 22



♀ Ref. 4575
↔ ↑ ↘
cm 35 x 34 x 23
☐ 15 x 18 cm



♀ Ref. 4500
↔ ↑ ↘
cm 26 x 19 x 15
☐ 12 x 8,5 cm



♀ Ref. 4577
↑ ↔ ↘
cm 75 x 68 x 43
☐ Ø 32 cm

resistente, limpio y actual

RESISTENCIA Y LIMPIEZA

Bronces Jordá garantiza que en la producción de sus artículos de acero utiliza el inoxidable AISI-304, recomendado por las acerías más importantes del mundo, por ser el que posee unas características idóneas para las funciones a la que están destinados nuestros productos.

Transformamos el acero cumpliendo con los requisitos más exigentes y sin alterar sus propiedades austeníticas para sacarle el máximo partido. Obtenemos estos productos utilizando la más moderna tecnología de estampación, embutición, plegado, soldadura, etc del acero inoxidable, combinándola con los años de experiencia en la manipulación de este metal.

RESISTÊNCIA E LIMPEZA

A Bronces Jordá garante que na produção dos seus artigos de aço utiliza o inoxidável AISI-304, recomendado pelas fábricas de aço mais importantes do mundo, por ser o que possui características ideais para as funções às quais os nossos produtos estão destinados.

Transformamos o aço cumprindo os requisitos mais exigentes e sem alterar as suas propriedades austeníticas, para tirar-lhe o máximo proveito. Obtemos estes produtos utilizando a mais moderna tecnologia de gravação, embutição, dobra, solda, etc. do aço inoxidável, combinando-a com os anos de experiência na manipulação deste metal.

RESISTENZA E PULIZIA

Bronces Jordá, garantisce che nella produzione dei propri articoli in acciaio si utilizza l'INOX AISI-304, raccomandato dalle più rilevanti acciaierie del mondo, perché è, in effetti, quello che possiede le caratteristiche idonee per la fusione cui vengono destinati in nostri prodotti.

Trasformiamo l'acciaio rispettando debitamente i requisiti più esigenti e senza alterare, in alcun modo, le sue proprietà austenitiche per così averne il massimo profitto. Otteniamo questi prodotti utilizzando la più avanzata tecnologia in stampatura, imbutitura, piegatura, saldatura, ecc. dell'acciaio inossidabile, combinandola anche con tutti gli anni d'esperienza nella manipolazione di suddetto metallo.

RESISTANCE AND CLEANLINESS

Bronces Jordá guarantees the use of AISI-304 stainless steel in the production of its items. This steel is recommended by the world's leading steelworks as possessing the perfect characteristics for the functions to which our products are destined.

We transform the steel in accordance with the most exacting requirements and without altering its authentic qualities in order to obtain the very best benefits. We obtain these products by employing the most advanced stainless steel stamping, pressing, folding, welding technology, etc., which we combine with years of experience of working with this metal.

RÉSISTANCE ET ENTRETIEN

Bronces Jordá garantit que, dans la production des ses articles en acier, il utilise l'inoxidable AISI-304, recommandé par les aciéries les plus importantes du monde, car il a des caractéristiques adaptées à l'usage auquel sont destinés nos produits.

Nous transformons l'acier en respectant les conditions les plus exigeantes et ceci sans altérer ses propriétés austénitiques afin de pouvoir en tirer le meilleur parti possible. Nous obtenons ces produits en utilisant les technologies les plus modernes pour travailler l'acier inoxydable en matière de forçage, emboutissage, pliage, collage, etc..., que nous combinons avec nos années d'expérience dans la manipulation de ce métal.

DEGELIJKHEID EN ONDERHOUD

Bronces Jordá garandeert dat voor de stalen modellen roestvrij staal AISI-304 wordt gebruikt, aanbevolen door de meest gerenommeerde staalbedrijven in de wereld, aangezien het de ideale eigenschappen bezit voor de functies waarvoor onze producten bestemd zijn.

Wij transformeren staal met inachtneming van de hoogste kwaliteitseisen en zonder de originele eigenschappen ervan te wijzigen, om het zo geschikt te maken voor zoveel mogelijk toepassingen. Wij verkrijgen onze producten door gebruikmaking van de modernste technieken voor het bedrukken, persen, plooiën, lassen, etc. van roestvrijstaal, in combinatie met onze jarenlange ervaring in deze sector.

acero inoxidable

stainless steel





O 189



D 187



O 192



O 191



D 192 - 193 - 194 - 198 - 199 - 202

O 194 - 195 - 196 - 197 - 198 - 199 - 200 - 201 - 202 - 203 - 204



O 190



D 188



D 206 - 207 - 208 - 209 - 210 - 211 - 212



D 212 - 213 - 214 - 215 - 216 - 217 - 218 - 219



D 189 - 190



O 196 - 197 - 200 - 204 - 205



O 188



O 190



D 192 - 193 - 194



D 180 - 181 - 182 - 183 - 184 - 185 - 186 - 187



D 180

O 204



D 181

ACABADOS NORMALIZADOS STANDARD FINISHES

Los productos mostrados a continuación tienen el acabado “pulido espejo” aunque algunos elementos grabados o superpuestos pueden tener diferente tonalidad para mejorar la estética del producto.

Las referencias acabadas con la letra C indican que el artículo también está disponible con el elemento de bronce superpuesto (Cristo, flores, etc) en acabado “cromado”. La primera referencia corresponde siempre a la foto que se muestra. Todos los artículos referenciados están disponibles para entrega inmediata.

Nas superfícies expostas á vista os nossos artigos têm um acabamento “polido brilhante” contudo em alguns elementos gravados ou sobrepostos podem ter um a tonalidade diferente para dar mais estética ao produto.

As referências acabadas com a letra C indicam que o produto também está disponível com um elemento de bronze sobreposto (Cristo, flor, etc) com o corresponde sempre à foto que se mostra. Todos os artigos referenciados estão disponíveis para entrega imediata.

Nelle superfici esposte a la vista, i nostri articoli hanno la rifinitura “finitura lucida”, anche se gli elementi stampati o sovrapposti, alcuni possono avere tonalità differenti per migliorare la qualità estetica del prodotto.

Le referenze finite con la lettera C, indicano che l'articolo inoltre è disponibile con l'elemento di bronzo sovrapposto (Cristi, fiori, etc) con la rifinitura “cromata”. La prima referenza corrisponde sempre alla foto che è indicata. Tutti gli articoli con referenza sono disponibili per la consegna immediata.

All visible surfaces of this range of products have a “shine finish” but some engravings and distinguishing parts fixed over them are offered in different shades or finish to improve their aesthetic appearance.

The letter C at the end of any reference number means that the distinguishing part has “chromed” finish (Christ, flower, etc). The first reference number identifies the article in the finish shown in catalogue. All articles with a reference number are available for immediate delivery.

Dans les surfaces exposées à la vue, nos articles ont la finition “poli miroir” bien que quelques éléments gravés ou superposés peuvent avoir différente tonalité afin d'améliorer l'esthétique ou produit.

Les références finies avec la lettre C indiquent que les articles sont aussi en disponibilité avec l'élément superposé (le Christ, fleurs, etc) en finition “cromado”. La première référence correspond toujours à la photo que l'on montre. Tous les articles de référence sont en disponibilité pour livraison immédiate.

De voorgestelde artikelen hebben de afwerking “poli miroir”, hoewel dat sommige gegraveerde als opgeplaatste artikelen een verschillende schakering kunnen vertonen teneinde de esthetiek van het product te verbeteren.

De referenties met de letter C op het einde, wijzen dat de artikelen ook beschikbaar zijn met een bronzen figuur (Christus, bloemen, enz...) met “cromado” afwerking.

De eerste referentie stemt altijd overeen met de foto die men toont. Al de andere artikelen zijn steeds beschikbaar voor een onmiddellijke levering.



Ref. 2210



Ref. 2210 C

MODERNO

ABCDEFGHIJKLMNOPQRSTUVWXYZ
 UVWXYZ 1234567890★†.-

Ref.	↑ cm
105	2,5 *+
107	4
108	5

PRISMÁTICO

ABCDEFGHIJKLMNOPQRSTUVWXYZ
 UVWXYZ 1234567890

Ref.	↑ cm
101	2,5 *+
103	4
104	5

IBÉRICO ADHESIVO

A B C D E F G
 H I J K L M N
 O P Q R S T U
 V W X Y Z 1 2 3 4 5 6 7
 8 9 0 * † . -

Ref.	↑ cm	. -
140	3 *+	Ref. 140
141	5	Ref. 141

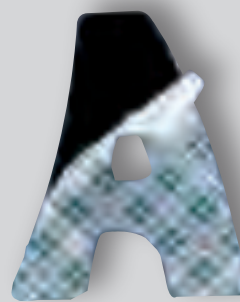

ADHESIVAS

* Con números

+ Con cruces y estrellas

* With numbers

+ With crosses and stars

* Com números

+ Com cruces e estrelas

ROMANO

ABCDEFGHIJKLMNOP
 OPQRSTUVWXYZ
 1234567890 ✕ ★ - '

Ref.	↑ cm
109	2 *+
110	2,5 **
111	3,5 **
112	4,5
113	5,5 *
114	8 *
115	12,5

PUNTOS • COMAS ,
 Ref. 300 Ø 0,6 cm. Ref. 302
 Ref. 301 Ø 0,8 cm.

GUIJONES - ACENTOS
 Ref. 303 cm. 1,7 Ref. 306
 Ref. 304 cm. 2,5
 Ref. 305 cm. 4
 Ref. 307 cm. 5

ROMANO ESTRECHO

ABCDEFGHIJKLMNOP
 OPQRSTUVWXYZ
 1234567890 ★ ✕ - '

Ref.	↑ cm
118	2,5 *+
119	3,5 **
120	4,5
122	6

≡ Ref. 380
 cm 6
 ≡ Ref. 382
 cm 10
 ≡ Ref. 385
 cm 20



≡ Ref. 400
 cm 5
 ≡ Ref. 401
 cm 7
 ≡ Ref. 403
 cm 9

* Avec numéros

* Con numeri

* Met nummers

+ Avec croix et étoiles

+ Con crocette e stelle

+ Met kruisjes en sterretjes

MEMORIAL

MEMORIAL



RECORTADAS DE CHAPA DE 4 mm DE ESPESOR
 UTILIZANDO TECNOLOGÍA DE CORTE POR AGUA.
 MADE IN 4mm THICKNESS SHEET BY WATER JET SYSTEM.
 PARA FIJACIÓN 2 AGUJEROS / FIXATION BY 2 HOLES

A B C D E F G H I

11.7 10.8 11.3 11.6 11.2 10.6 12.0 12.2 6.1

J K L M N Ñ O P Q

10.2 12.4 10.2 13.9 11.1 11.1 11.9 10.3 11.9

R S T U V W X Y Z

12.1 10.0 11.4 11.5 11.7 14.8 12.7 11.5 10.1

1 2 3 4 5

7.4 9.5 9.5 10.1 9.5

6 7 8 9 0

9.8 9.9 9.5 9.8 10.0

★ † ■ _ ●

11.9 10.3 7.2 7.2 3.6

A partir de los 3 cm, que es la altura mínima, podemos fabricarlos con la altura que precisen.
 From 3 cm, that is the minimum height, we can make them with the height you need.

HELVETICA UNIDA

JOINED HELVETICA

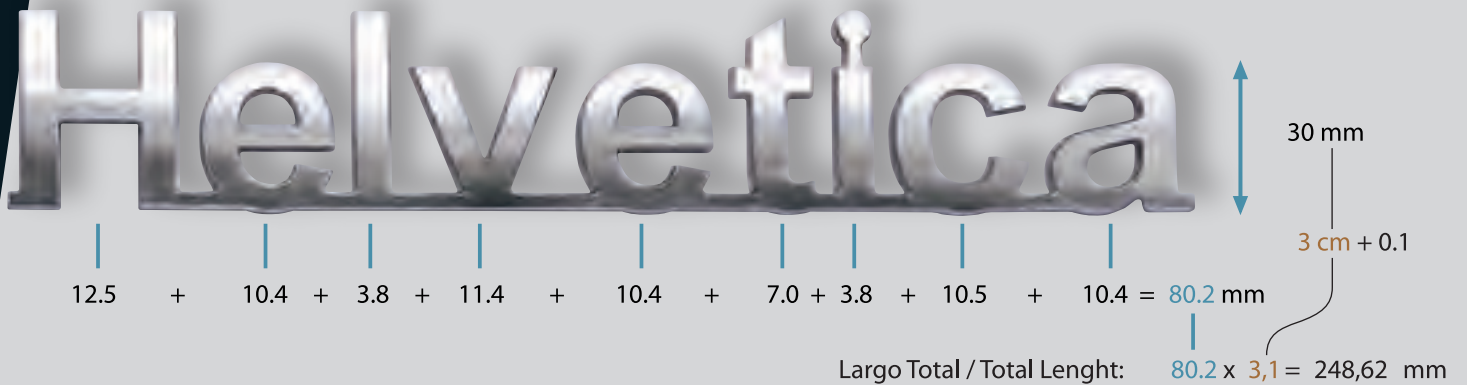
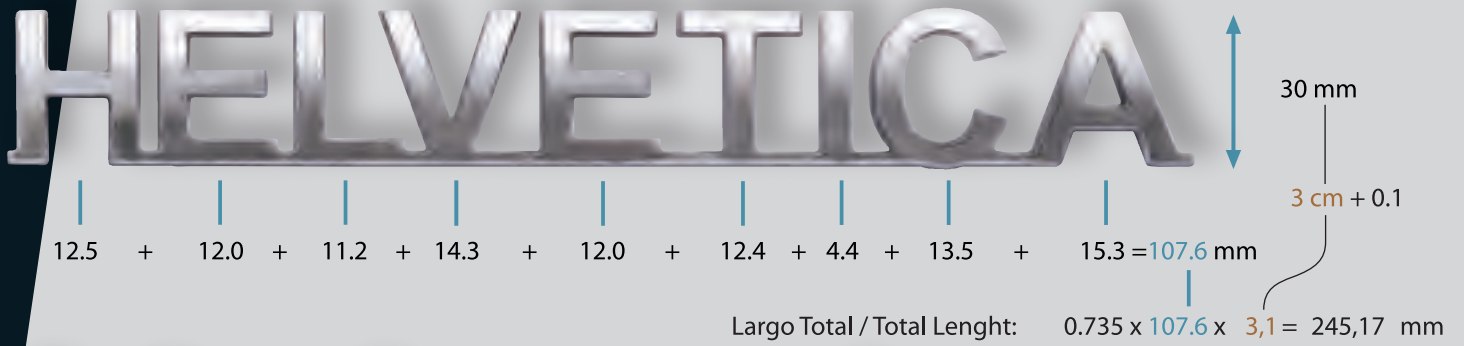

RECORTADAS DE CHAPA DE 4 mm DE ESPESOR
 UTILIZANDO TECNOLOGÍA DE CORTE POR AGUA.
 MADE IN 4mm THICKNESS SHEET BY WATER JET SYSTEM.
 PARA FIJACIÓN 2 AGUJEROS / FIXATION BY 2 HOLES

A B C D E F

15.3 13.0 13.5 13.0 12.0 11.0

G H I J K L M

14.4 12.5 4.4 10.3 13.9 11.2 14.8

N Ñ O P Q R

12.4 12.4 14.8 12.1 15.3 13.9

S T U V W X

12.7 12.4 12.5 14.3 19.5 14.3

Y Z 1 2 3 4 5 6 7 8 9 0 _ * ± .

14.4 12.7 7.6 10.8 10.7 11.4 10.8 10.7 10.5 10.6 10.7 10.5 7.2 12.6 11.2 4.0

a b c d e f g

10.4 10.8 10.5 10.8 10.4 7.9 10.8

h i j k l m n ñ

10.2 3.8 6.0 10.3 3.8 15.7 10.2 10.2

o p q r s t u

11.4 10.8 10.8 7.6 10.4 7.0 10.2

v w x y z

11.4 15.9 11.5 11.3 10.0

A partir de los 3 cm, que es la altura mínima de una vocal minúscula, podemos fabricarlos con la altura que precisen.

También podemos suministrarlas sueltas

From 3 cm, that is the minimum height of one small vowel, we can make them with the height you need. Also we can serve detached letters and numbers.

ITALICA

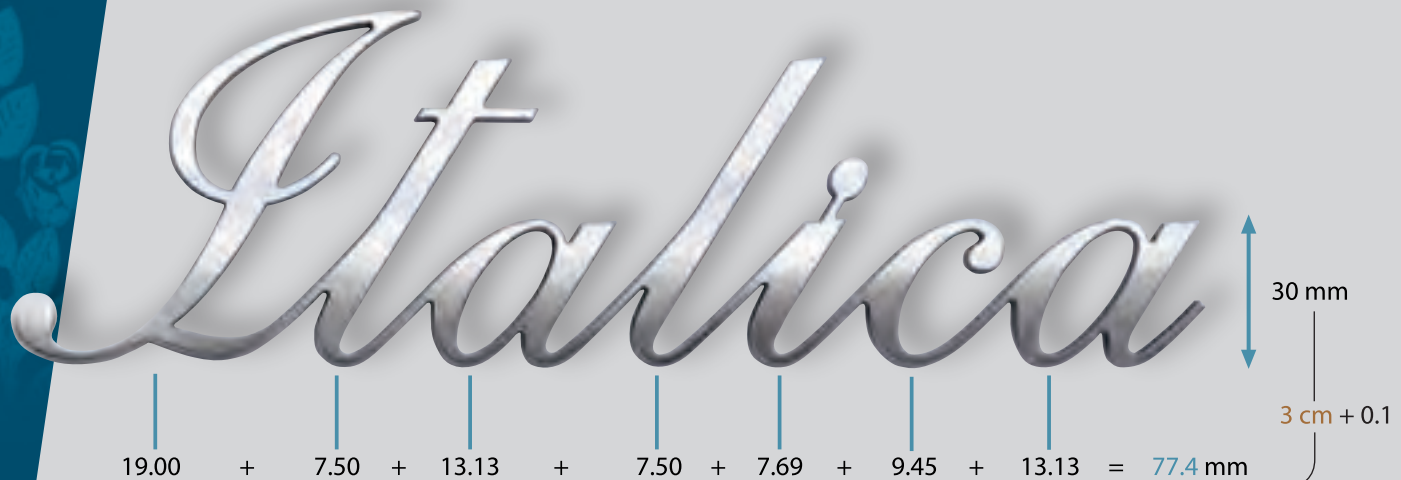

19.00 + 7.50 + 13.13 + 7.50 + 7.69 + 9.45 + 13.13 = 77.4 mm

Largo Total / Total Length: 77.4 x 3,1 = 239.94 mm

RECORTADAS DE CHAPA DE 4 mm DE ESPESOR
 UTILIZANDO TECNOLOGÍA DE CORTE POR AGUA.
 MADE IN 4mm THICKNESS SHEET BY WATER JET SYSTEM.
 PARA FIJACIÓN 2 AGUJEROS / FIXATION BY 2 HOLES

<i>A</i>	<i>B</i>	<i>C</i>	<i>D</i>	<i>E</i>	<i>a</i>	<i>b</i>	<i>c</i>	<i>d</i>	<i>e</i>		
26.9	29.7	19.3	28.1	15.8	13.13	11.12	9.45	13.13	9.49		
<i>F</i>	<i>G</i>	<i>H</i>	<i>I</i>	<i>J</i>	<i>f</i>	<i>g</i>	<i>h</i>	<i>i</i>	<i>j</i>		
22.2	19.6	27.5	19.0	24.0	7.59	13.13	12.37	7.69	7.77		
<i>K</i>	<i>L</i>	<i>M</i>	<i>N</i>	<i>Ñ</i>	<i>k</i>	<i>l</i>	<i>m</i>	<i>n</i>	<i>ñ</i>		
30.1	22.2	34.5	31.6	31.6	12.78	7.50	20.25	14.87	14.87		
<i>O</i>	<i>P</i>	<i>Q</i>	<i>R</i>	<i>S</i>	<i>o</i>	<i>p</i>	<i>q</i>	<i>r</i>	<i>s</i>		
17.4	24.3	22.3	27.8	20.1	10.98	12.43	12.88	11.20	8.02		
<i>T</i>	<i>U</i>	<i>V</i>	<i>W</i>	<i>X</i>	<i>t</i>	<i>u</i>	<i>v</i>	<i>w</i>	<i>x</i>		
22.1	21.5	19.3	27.8	23.7	7.50	13.13	13.38	18.69	12.12		
<i>Y</i>	<i>Z</i>	<i>y</i>	<i>z</i>	<i>-</i>	<i>+</i>	<i>*</i>	14.62	11.01	8.87	8.87	9.73
23.7	20.4	<i>1</i>	<i>2</i>	<i>3</i>	<i>4</i>	<i>5</i>	7.32	8.9	8.8	7.2	9.2
		<i>6</i>	<i>7</i>	<i>8</i>	<i>9</i>	<i>0</i>	8.90	8.45	7.95	8.90	7.63

A partir de los 3 cm, que es la altura mínima de una vocal minúscula, podemos fabricarlos con la altura que precisen.
 From 3 cm, that is the minimum height of one small vowel, we can make them with the height you need.

MAGNA



RECORTADAS DE CHAPA DE 4 mm DE ESPESOR
 UTILIZANDO TECNOLOGÍA DE CORTE POR AGUA.
 MADE IN 4mm THICKNESS SHEET BY WATER JET SYSTEM.

PARA FIJACIÓN 2 AGUJEROS / FIXATION BY 2 HOLES

<i>A</i> 18.46	<i>B</i> 19.49	<i>C</i> 13.76	<i>D</i> 16.04	<i>E</i> 12.63	<i>a</i> 11.94	<i>b</i> 10.38	<i>c</i> 8.84	<i>d</i> 11.94	<i>e</i> 9.38	<i>f</i> 7.65	<i>g</i> 11.94			
<i>F</i> 14.66	<i>G</i> 13.31	<i>H</i> 18.77	<i>I</i> 14.66	<i>J</i> 13.98	<i>h</i> 12.56	<i>i</i> 6.54	<i>j</i> 6.94	<i>k</i> 11.33	<i>l</i> 6.52	<i>m</i> 18.57	<i>n</i> 12.93			
<i>K</i> 17.74	<i>L</i> 13.28	<i>M</i> 21.71	<i>N</i> 19.14	<i>Ñ</i> 19.14	<i>ñ</i> 12.93	<i>o</i> 10.47	<i>p</i> 12.56	<i>q</i> 11.94	<i>r</i> 7.40	<i>s</i> 8.70	<i>t</i> 6.52	<i>u</i> 11.97		
<i>O</i> 12.61	<i>P</i> 14.66	<i>Q</i> 12.76	<i>R</i> 17.69	<i>S</i> 14.47	<i>v</i> 11.60	<i>w</i> 16.07	<i>x</i> 10.82	<i>y</i> 11.94	<i>z</i> 9.83	- 9.33	+ 9.33	* 9.61		
<i>T</i> 14.66	<i>U</i> 15.69	<i>V</i> 12.76	<i>W</i> 18.98	<i>X</i> 16.02	<i>1</i> 8.65	<i>2</i> 8.78	<i>3</i> 8.98	<i>4</i> 7.60	<i>5</i> 9.36	<i>6</i> 8.71	<i>7</i> 7.47	<i>8</i> 8.69	<i>9</i> 8.71	<i>0</i> 8.57
<i>Y</i> 14.30	<i>Z</i> 14.30													

A partir de los 3 cm, que es la altura mínima de una vocal minúscula, podemos fabricarlos con la altura que precisen.
 From 3 cm, that is the minimum height of one small vowel, we can make them with the height you need.

GÓTICA UNIDA

JOINED GÓTICA

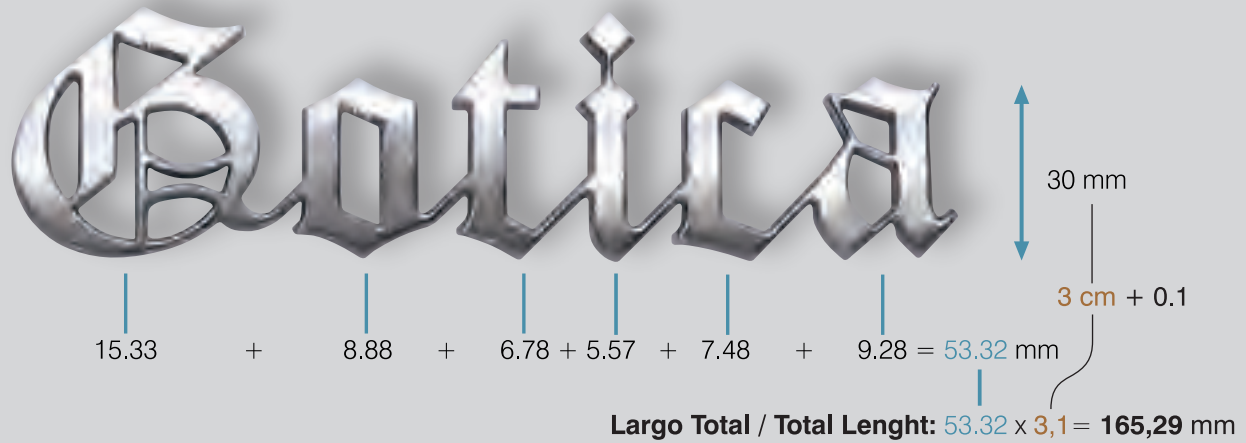

**RECORTADAS DE CHAPA DE 4 mm DE ESPESOR
UTILIZANDO TECNOLOGÍA DE CORTE POR AGUA.
MADE IN 4mm THICKNESS SHEET BY WATER JET SYSTEM.
PARA FIJACIÓN 2 AGUJEROS / FIXATION BY 2 HOLES**

A 14.02	B 15.94	C 13.80	D 16.26	E 14.08	a 9.28	b 8.94	c 7.48	d 9.20	e 7.80
F 17.05	G 15.33	H 16.34	I 12.49	J 14.08	f 6.37	g 10.60	h 8.92	i 5.57	j 6.58
K 15.69	L 13.58	M 19.48	N 18.95	Ñ 18.95	k 9.21	l 5.63	m 14.63	n 10.54	ñ 10.54
O 16.34	P 16.13	Q 16.34	R 16.01	S 16.58	o 8.88	p 9.56	q 9.45	r 8.82	s 9.22
T 15.75	U 16.58	V 14.57	W 19.31	X 14.02	t 6.78	u 10.39	v 9.25	w 13.31	x 10.29
Y 15.22	Z 13.07	+ 9.63	* 10.27	- 7.69	1 6.09	2 8.61	3 8.56	4 8.80	5 8.24
					6 8.41	7 8.54	8 8.28	9 8.44	0 8.46

A partir de los 2,5 cm, que es la altura mínima de una vocal minúscula, podemos fabricarlos con la altura que precisen. También podemos suministrarlas sueltas.

From 2,5 cm, that is the minumum height of one small vowel, we can make them with the height you need. Also we can serve detached letters and numbers.

DISEÑOS PERSONALIZADOS EN ACERO INOXIDABLE

SPECIAL DESIGNS IN STAINLESS STEEL

UTILIZANDO TECNOLOGÍA DE CORTE POR AGUA / BY WATER JET SYSTEM



- ⇒ Ref. 4310
cm 7,6 x 5,6
- ⇒ Ref. 4311
cm 8,5 x 6,6
- ⇒ Ref. 4312
cm 10 x 7,2
- ⇒ Ref. 4313
cm 11 x 8,2



- ⇒ Ref. 4315
cm 9 x 7
- ⇒ Ref. 4316
cm 10 x 8
- ⇒ Ref. 4317
cm 12 x 9
- ⇒ Ref. 4318
cm 15 x 11



- ⇒ Ref. 4330
cm 8 x 6
- ⇒ Ref. 4331
cm 9 x 7
- ⇒ Ref. 4332
cm 10 x 8
- ⇒ Ref. 4333
cm 12 x 9



- ⇒ Ref. 4320
cm 8 x 6
- ⇒ Ref. 4321
cm 9 x 7
- ⇒ Ref. 4322
cm 10 x 8
- ⇒ Ref. 4323
cm 12 x 9
- ⇒ Ref. 4324
cm 15 x 11
- ⇒ Ref. 4325
cm 18 x 13

Las medidas indican las dimensiones de la fotocerámica. The mesures show the photo sizes. As medidas indicam as dimensões da fotocerâmica. Les mesures indiquent les dimensions de la photo céramique. Le mesure indicano le dimensione della fotoceramica. De afmetingen worden weergegeven door de foto's.



EN CHAPA ESTAMPADA

⇒ Ref. 390
cm 15 x 11

⇒ Ref. 391
cm 22 x 15

⇒ Ref. 393
cm 42 x 30



⇒ Ref. 355
cm 36 x 12



⇒ Ref. 356
cm 22 x 14



⇒ Ref. 350
cm 15



⇒ Ref. 352
cm 15



Ref. 3699
Ø cm 10
● 1 cm



Ref. 3700
Ø cm 10
○ 1 cm



Ref. 3710
Ø cm 10
● 1 cm

Ref. 3707
Ø cm 12
● 1,4 cm

Ref. 3707 L
12 cm



Ref. 3701
Ø cm 8
● 0,8 cm



Ref. 3702
Ø cm 6
● 0,6 cm



Ref. 3705
Ø cm 7
● 0,8 cm



Ref. 3708
Ø cm 7
● 0,8 cm



Ref. 3801
Ø 5 cm



Ref. 3802
Ø 5 cm



Ref. 3803
Ø 4 cm



Ref. 4114
enganche cadena
Ø 3,5 cm

Ref. 4110
cm 10 x 4,5 ← 100 cm



▽ Ref. 3901
▽ Ref. 3902
▤ Ref. 3903
✕ Ref. 3901 S
cm 3,5 x 3,5

▽ Ref. 3918
▽ Ref. 3919
Ø 3,5 cm

▽ Ref. 3910
▽ Ref. 3911
✕ Ref. 3910 S
Ø 3 cm

▽ Ref. 3916
▽ Ref. 3917
✕ Ref. 3916 S
cm 4 x 4

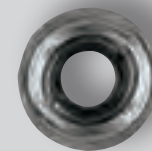

Ref. 3900
cm 3,5 x 3,5

Ref. 3913
Ø 3,5 cm

Ref. 3920
Ø 3,5 cm
▽ M8 x 10 cm

Ref. 5000
Ø 1,4 cm
Ref. 5001(liso/smooth)
cromados
chromo finish

Ref. 3907
cm 3,5 x 3,5
(soporte corona)

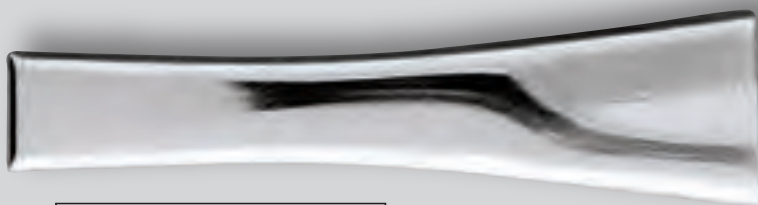

Ref. 3999 cm 6,5
Ref. 4000 cm 8
Ref. 4001 cm 10
Ref. 4002 cm 12
Ref. 4003 cm 15
Ref. 4004 cm 20



Ref. 4025 cm 10 ● Ø 0,8 cm
Ref. 4027 cm 15 ● Ø 1 cm

┌ **Ref. 4017** cm 2 x 2 x 2
┌ **Ref. 4018** cm 2 x 2,5 x 2
┌ **Ref. 4019** cm 2 x 3 x 2
┌ **Ref. 4020** cm 2 x 4 x 2
┌ **Ref. 4021** cm 2 x 6 x 2
▤ **Ref. TM520**
▤ **Ref. TACO5**



Ref. 4203
cm 11,5 x 12
15 cm



Ref. 4208
cm 18,5 x 7
12 cm



Ref. 4209
cm 23,5 x 6
12 cm



Ref. 4204
cm 12,5 x 6
15 cm



Ref. 4210
cm 17,5 x 5,5
15 cm

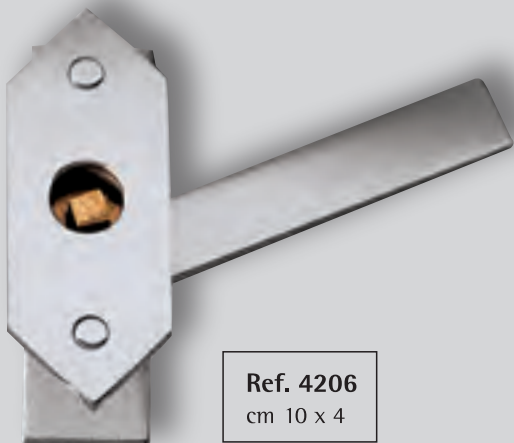

Ref. 4206
cm 10 x 4



Ref. 4205
cm 10,6 x 4
Ref. 4205 L

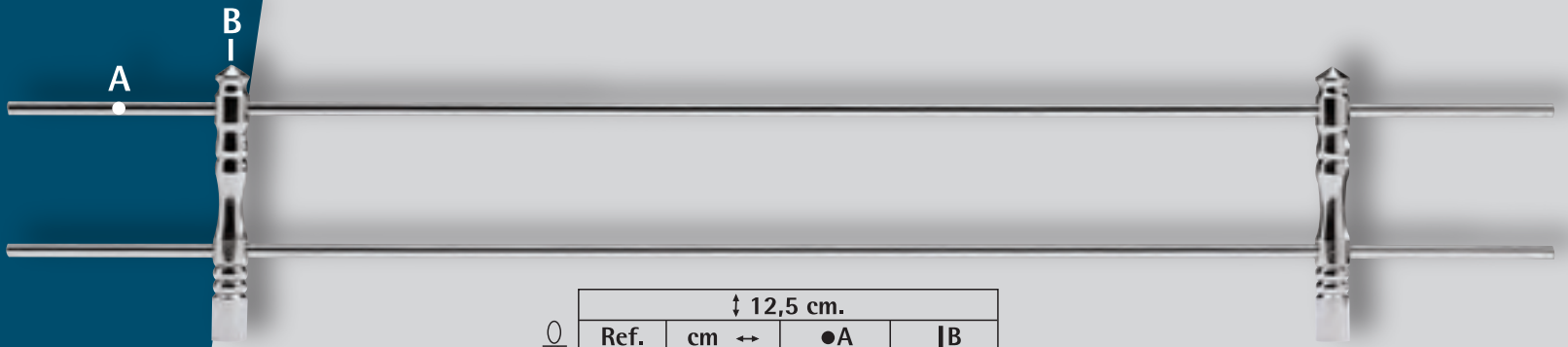

↓ 12,5 cm.

Ref.	cm ↔	●A	B
4270	70	2	2
4280	80	2	2
4380	80	2	3
4385	85	2	3
4390	90	2	3
4395	95	2	3

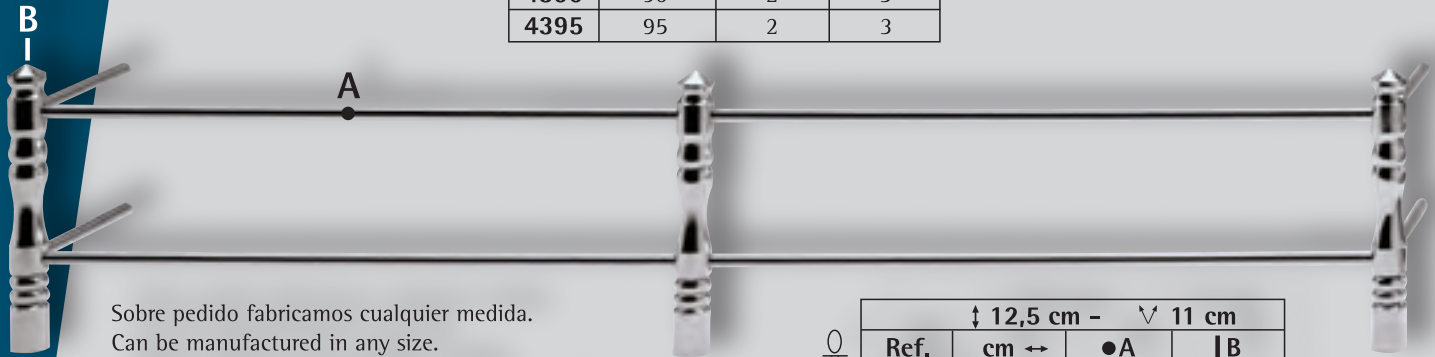

↓ 12,5 cm - ∇ 11 cm

Ref.	cm ↔	●A	B
4380 L	80	2	3
4390 L	90	2	3

Sobre pedido fabricamos cualquier medida.
 Can be manufactured in any size.
 Podem fabricar-se de qualquer medida.
 Ils peuvent être fabriqués dans n'importe quelle mesure.
 Si possono fabbricare di qualsiasi misura.
 Zit kunnen in om't even welke afmeting gemaakt worden



⇒ Ref. 3445
 cm 17 x 18 x 9,5
 ∇ D 12



⇒ Ref. 3443
 cm 30 x 16 x 10
 ∇ D 12 (2 unidades)



⇒ Ref. 3454
 cm 17 x 18 x 9
 ∇ D 12



⇒ Ref. 3446
 ⇒ Ref. 3446 C
 cm 30 x 13 x 9
 ∇ D 44
 ⊗ R 44



⇒ Ref. 333
cm 25 x 13 x 8
∇ D 124
⊗ R 124



⇒ Ref. 456
cm 21 x 13 x 7,5
∇ D 40



⇒ Ref. 538
cm 33 x 12 x 8
∇ D 51
⊗ R 51



⇒ Ref. 458
cm 20 x 13,5 x 8
∇ D 458



⇒ Ref. 540
cm 33 x 12 x 8
∇ D 51
⊗ R 51



⇒ Ref. 535
cm 33 x 12 x 8
∇ D 51
⊗ R 51



⇒ Ref. 3447
⇒ Ref. 3447 C
cm 33 x 12 x 8
∇ D 51
⊗ R 51



⇒ Ref. 537
cm 33 x 12 x 8
∇ D 51
⊗ R 51



⇒ Ref. 450
cm 18 x 11 x 6,5
∇ D 15



⇒ Ref. 454
cm 20 x 10 x 8,5
⇒ Ref. 454 B
cm 21,5 x 10 x 7,5
⇒ 9,5 x 6,2 cm
∇ D 4 P



∅ Ref. 451
cm 19 x 9 x 10
Ref. 451 M
cm 19 x 9 x 13
RD 97 C



∅ Ref. 555
cm 19 x 9 x 11
RD 97 C



♀ Ref. 451 B
cm 22 x 8
∅ 8 cm
RD 97 C



♀ Ref. 556 B
cm 20 x 8'5
∅ 8 cm
RD 97 C



∅ Ref. 556
cm 19 x 8,5 x 11
RD 97 C



∅ Ref. 558
cm 16 x 7 x 9
D 558



∅ Ref. 599
cm 20 x 8,5 x 10,5
∇ ⊗ RD 97 C



∅ Ref. 518
cm 19 x 8 x 12
∇ D 68



∅ Ref. 519
cm 17 x 8 x 9
∇ V 1

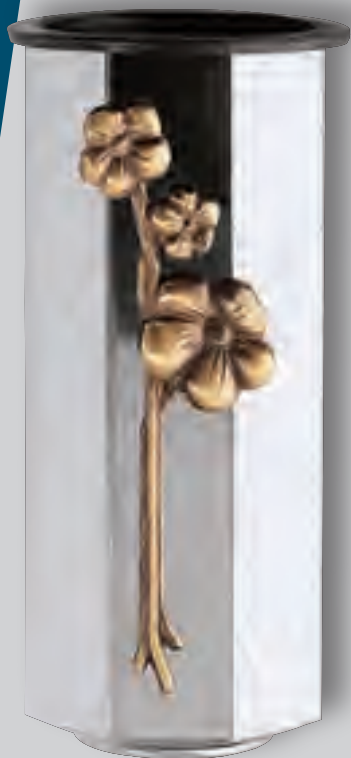

∅ Ref. 440
cm 18 x 9
♀ Ref. 440 B
cm 20 x 8
♂ ∅ 7 cm
∇ D 58



∅ Ref. 470
cm 18 x 9
♀ Ref. 470 B
cm 19 x 9
♂ ∅ 8 cm
∇ D 58



∅ Ref. 471
cm 18 x 7,5 x 8,5
♀ Ref. 471 B
cm 19 x 7,5 x 7,5
♂ ∅ 5,5 cm
∇ V 1



♀ Ref. 519 B
cm 20 x 8
☐ Ø 8 cm
🔥 V 1



♀ Ref. 518 B
cm 20 x 8 x 11,5
☐ Ø 8 cm
∇ D 68



≠ Ref. 3472
cm 20 x 8,5 x 9
∇ ⊗ RD 97 C



♀ Ref. 442 B
cm 19 x 7,5 x 8
☐ Ø 5,5 cm
🔥 V 1



≠ Ref. 439
cm 18 x 9
♀ Ref. 439 B
cm 20 x 8
☐ Ø 7 cm
∇ D 58



≠ Ref. 442
cm 18 x 7,5 x 9
🔥 V 1



♀ Ref. 520 B
cm 21 x 10,5

♂ 7 cm
▽ D 73

♀ Ref. 527 B
cm 28 x 14

♂ 10,5 cm
▽ D 79



♂ Ref. 520
cm 19 x 10,5

♂ Ref. 520 M
cm 19 x 10,5 x 13,5
▽ D 73



♂ Ref. 525
cm 18 x 11 x 11,5
▽ D 75



♂ Ref. 487
cm 19 x 12 x 7,5
▽ D 27



♂ Ref. 514
cm 13 x 8,5
▽ D 71

♂ Ref. 515
cm 16 x 10
▽ D 73

♂ Ref. 516
cm 19 x 11
▽ D 73



♀ Ref. 514 B
cm 13,5 x 7
♂ 4 cm
▽ D 71

♀ Ref. 515 B
cm 18 x 8
♂ 6 cm
▽ D 73

♀ Ref. 516 B
cm 21 x 9
♂ 7 cm
▽ D 73

♀ Ref. 517 B
cm 28 x 12,5
♂ 10,5 cm
▽ D 79



∅ Ref. 3480
cm 18 x 9 x 11
∅ Ref. 3480 M
cm 18 x 9 x 14
∇ D 77



∅ Ref. 3480 B
cm 21 x 9
∇ 7 cm
∇ D 77



∅ Ref. 3420 B
cm 28 x 12
∇ ∅ 8 cm
∇ D 3420



∅ Ref. 3408
cm 17 x 7 x 8
∇ D 103



∅ Ref. 3425
cm 17 x 10 x 6
∇ D 18



∅ Ref. 3423
cm 17 x 10 x 6
∇ D 18



∅ Ref. 477
cm 18 x 10 x 7,5
♀ Ref. 477 B
cm 20 x 10 x 6,5
∇ D 4 P



∅ Ref. 521
cm 19 x 10 x 7
♀ Ref. 521 B
cm 21 x 10 x 6,5
∇ V 1



♀ Ref. 472
cm 21 x 10 ∇ 9,5 cm
∇ D 4 P (2 unidades)



∅ Ref. 478
cm 18 x 10 x 8
∇ D 4 P



∅ Ref. 522
cm 19 x 10 x 8
♀ Ref. 522 T
cm 21 x 10 x 7
∇ V 1



∅ Ref. 476
cm 18 x 10 x 8
∇ D 4 P



≠0 Ref. 479
cm 18 x 10 x 11,5
∇ D 4 P



≠0 Ref. 3428 I
cm 18 x 9,5 x 6,5
∇ D 4



≠0 Ref. 3428 D
cm 18 x 9,5 x 6,5
∇ D 4



≠0 Ref. 551
cm 18 x 9,5 x 7,5
∇ D 4



≠0 Ref. 577
cm 18 x 9,5 x 7,5
∇ D 4



≠0 Ref. 576
cm 18 x 9,5 x 7,5
∇ D 4



≠D Ref. 3422
cm 17 x 10 x 8
≠D Ref. 3413
cm 17 x 10 x 5
∇ D 18



≠D Ref. 3427
cm 17 x 10 x 6
∇ D 18



≠O Ref. 3400
cm 17 x 6,5 x 7,5
O Ref. 3400 B
cm 18 x 6,5
≠D 6 cm
∇ D 103

≠O Ref. 3400 M
cm 17 x 6,5 x 8
∇ D 103



≠O Ref. 3440
cm 18 x 9,5 x 6,5
∇ D 4



≠O Ref. 3464
cm 14 x 9,5 x 6,5
∇ D 2
≠O Ref. 3426
cm 18 x 9,5 x 6,5
∇ D 4



≠O Ref. 3424
cm 18 x 9,5 x 6,5
∇ D 4



≠O Ref. 3466
cm 14 x 9,5 x 6,5
∇ D 2



♀ Ref. 3416 B
cm 21 x 8
♂ ∅ 8 cm
∇ D 68



∅ Ref. 3416
cm 19 x 8 x 8,5
∅ Ref. 3416 L *
↻ Ref. 3416 G
cm 19 x 8 x 12
∇ D 68



∅ Ref. 3457
cm 17 x 10 x 10,5
♀ Ref. 3457 B
cm 18,5 x 10 x 9
♂ 6 cm
↻ Ref. 3457 G
cm 17 x 10 x 13,5
∇ D 100



∅ Ref. 3456
cm 17 x 10 x 10,5
∇ D 100



∅ Ref. 3451
cm 17 x 10,5 x 10
♀ Ref. 3451 B
cm 20 x 9
♂ 7 cm
∇ D 100



∅ Ref. 3481
cm 18 x 9 x 10,5
∇ D 77



∅ Ref. 444
cm 14,5 x 6 x 7
♀ Ref. 444 B
cm 16 x 6
🔥 V 9



∅ Ref. 3459
cm 12 x 5 x 6
▽ D 56



∅ Ref. 445
cm 14,5 x 6 x 7
♀ Ref. 445 B
cm 16 x 6
🔥 V 9



∅ Ref. 3462
cm 12 x 5 x 6
∅ Ref. 3462 A 
cm 12 x 5 x 5,5
▽ D 56



♀ Ref. 3462 B
cm 13,5 x 5
☞ Ø 5,5 cm
▽ D 56



∅ Ref. 3430
cm 18 x 9 x 11
☞ Ref. 3430 M
♀ Ref. 3430 B
cm 21 x 9
☞ 7 cm
▽ D 58



∅ Ref. 3404
cm 21 x 6 x 9,5
▽ D 65



∅ Ref. 420
cm 14 x 9 x 10
♀ Ref. 420 B
cm 15 x 9
☞ Ø 6,5 cm
▽ V 4



∅ Ref. 430
cm 17 x 9 x 10
♀ Ref. 430 B
cm 17 x 9
☞ Ø 5,5 cm
▽ V 3



∅ Ref. 430 C
cm 52 x 18 x 12
∇ V 3



♀ Ref. 460 P ACABADO PULIDO/POLISHED FINISH
♀ Ref. 460 ACABADO MATE/ DULL FINISH
♀ ☀ Ref. 460 R SOLAR MATE/ DULL
cm 21 x 14,5 ∅ 11,5 cm
□ V 460



♀ Ref. 462 P ACABADO PULIDO/POLISHED FINISH
♀ Ref. 462 ACABADO MATE/ DULL FINISH
♀ ☀ Ref. 462 R SOLAR MATE/ DULL
cm 21 x 12 ∅ 9,8 cm
□ V 462



♀ Ref. 432 B
cm 25 x 14 x 14
∅ 11 x 11 cm
□ V 432



∅ Ref. 755
cm 20 x 11 x 13
♀ Ref. 755 B
cm 21 x 11
∅ 6,5 cm
∇ V 755

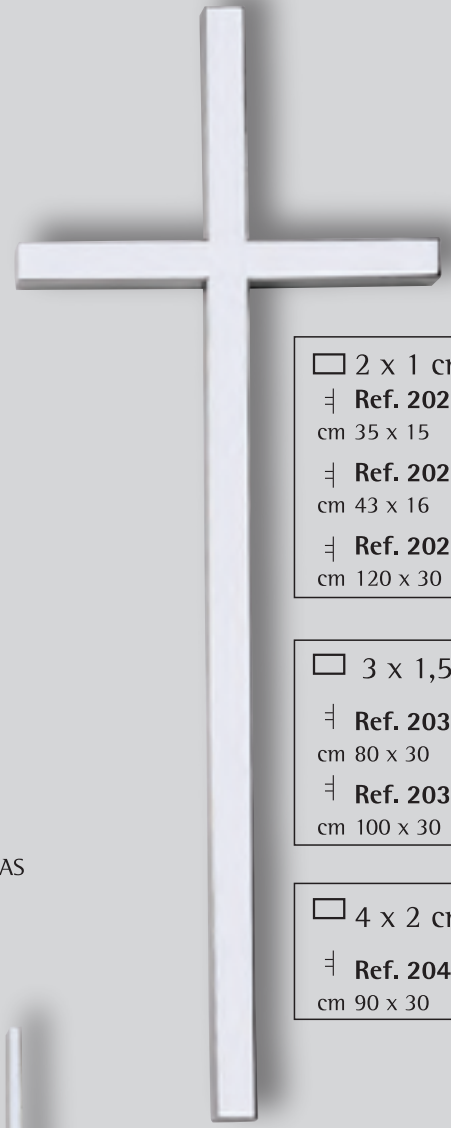

□ 2 x 1 cm
 † Ref. 2025-B
 cm 35 x 15
 † Ref. 2025-C
 cm 43 x 16
 † Ref. 2025-K
 cm 120 x 30

□ 3 x 1,5 cm
 † Ref. 2035-I
 cm 80 x 30
 † Ref. 2035-K
 cm 100 x 30

□ 4 x 2 cm
 † Ref. 2045-C
 cm 90 x 30

† Ref. 2019 *
 cm 50 x 17
 ○ 1,6 x 4,4 cm

*HASTA FIN EXISTENCIAS
 *WHILE STOCK LAST

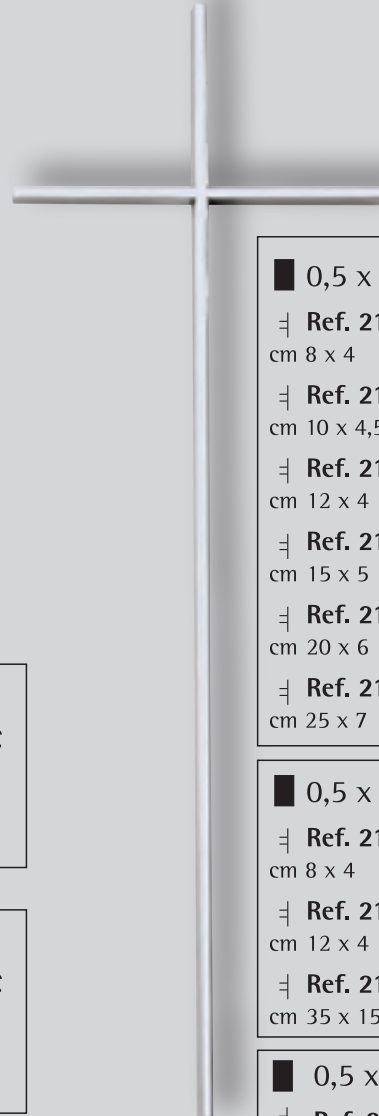
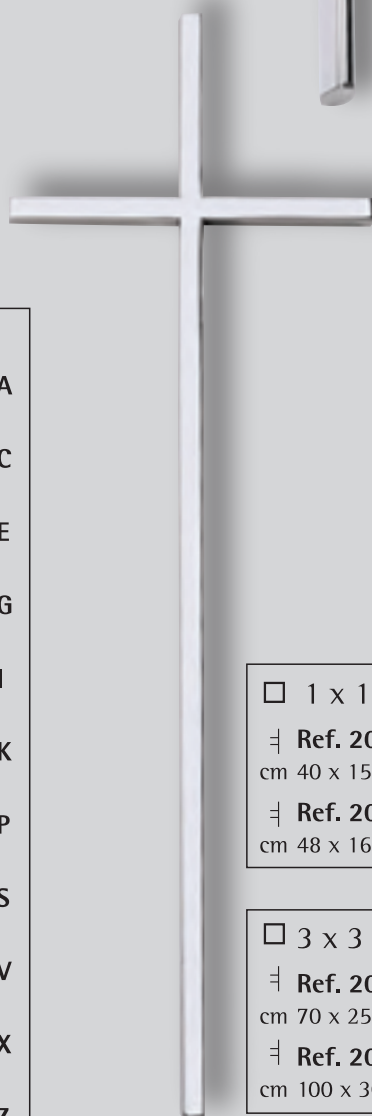

□ 1,5 x 3 cm
 † Ref. 2030-I
 cm 70 x 24
 † Ref. 2030-K
 cm 80 x 25
 † Ref. 2030-M
 cm 90 x 27
 † Ref. 2030-P
 cm 100 x 28
 † Ref. 2030-T
 cm 120 x 32
 † Ref. 2030-V
 cm 130 x 34
 † Ref. 2030-Y
 cm 150 x 36

□ 1 x 2 cm
 † Ref. 2020-A
 cm 20 x 10
 † Ref. 2020-C
 cm 25 x 12
 † Ref. 2020-E
 cm 35 x 14
 † Ref. 2020-G
 cm 40 x 15
 † Ref. 2020-I
 cm 45 x 16
 † Ref. 2020-K
 cm 50 x 17
 † Ref. 2020-P
 cm 70 x 24
 † Ref. 2020-S
 cm 80 x 27
 † Ref. 2020-V
 cm 90 x 30
 † Ref. 2020-X
 cm 100 x 30
 † Ref. 2020-Z
 cm 120 x 32

□ 2 x 4 cm
 † Ref. 2040-G
 cm 100 x 29

□ 1 x 1 cm
 † Ref. 2050-C
 cm 40 x 15
 † Ref. 2050-E
 cm 48 x 16

□ 3 x 3 cm
 † Ref. 2080-C
 cm 70 x 25
 † Ref. 2080-E
 cm 100 x 30

■ 0,5 x 1 cm
 † Ref. 2140-C
 cm 8 x 4
 † Ref. 2140-D
 cm 10 x 4,5
 † Ref. 2140-E
 cm 12 x 4
 † Ref. 2140-G
 cm 15 x 5
 † Ref. 2140-I
 cm 20 x 6
 † Ref. 2140-K
 cm 25 x 7

■ 0,5 x 1 cm
 † Ref. 2140-M
 cm 30 x 8
 † Ref. 2140-P
 cm 35 x 10
 † Ref. 2140-X
 cm 35 x 15
 † Ref. 2140-R
 cm 40 x 12
 † Ref. 2140-S
 cm 40 x 15
 † Ref. 2140-T
 cm 45 x 15

■ 0,5 x 1,5 cm
 † Ref. 2145-C
 cm 8 x 4
 † Ref. 2145-E
 cm 12 x 4
 † Ref. 2145-X
 cm 35 x 15

■ 0,5 x 1,5 cm
 † Ref. 2145-S
 cm 40 x 15
 † Ref. 2145-T
 cm 45 x 15

■ 0,5 x 2 cm
 † Ref. 2137-C
 cm 40 x 15

■ 0,5 x 2 cm
 † Ref. 2137-E
 cm 45 x 16



≡ Ref. 2098
cm 40 x 19
≡ Ref. 2099
cm 45 x 21
■ 1,5 x 0,5 cm

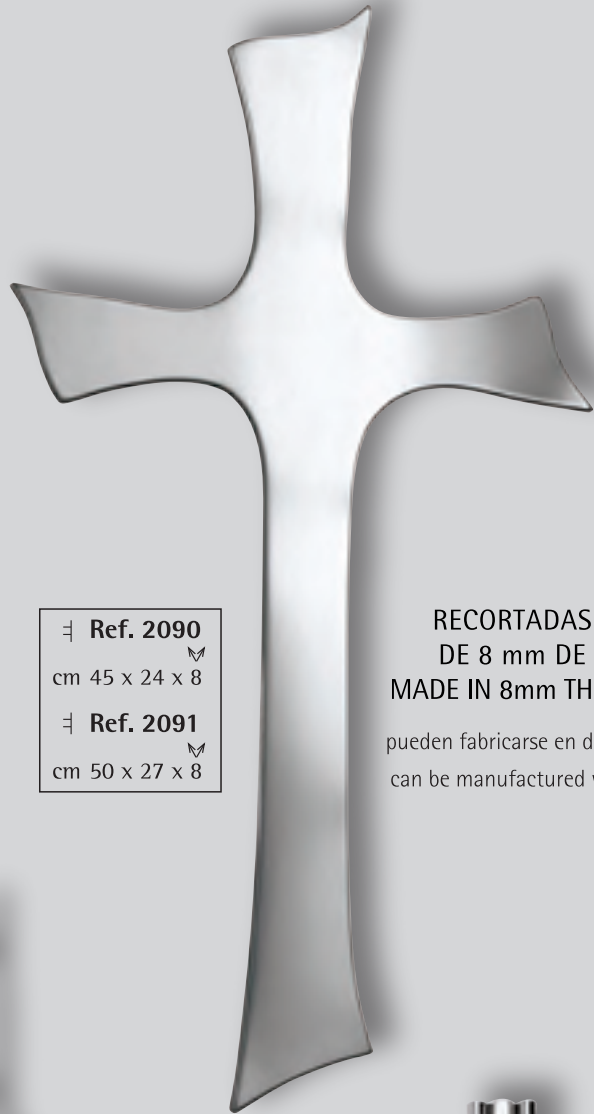

≡ Ref. 2090
cm 45 x 24 x 8
≡ Ref. 2091
cm 50 x 27 x 8

RECORTADAS DE CHAPA
DE 8 mm DE ESPESOR /
MADE IN 8mm THICKNESS SHEET

pueden fabricarse en diferentes tamaños /
can be manufactured with different sizes



≡ Ref. 2334
cm 44 x 19
● 0,8 cm
■ 1 x 0,5 cm



≡ Ref. 2322
cm 45 x 18
■ 0,5 x 1 cm



≡ Ref. 2336
cm 43 x 17
● Ø 8 cm
● 1 cm



≡ **Ref. 2339**
cm 45 x 16 x 3,5
□ 3 x 1,5 cm
● Ø 1 cm



≡ **Ref. 2102**
cm 45 x 18
□ 1 x 2 cm
■ 0,5 x 1 cm



≡ **Ref. 2146**
cm 45 x 16
■ 1 x 0,5 cm



≡ **Ref. 2332**
cm 45 x 20
□ 1 x 1 cm
● Ø 0,8 cm



≡ Ref. 2350 *
cm 47 x 19 x 2
○ 4,4 x 1,6 cm

*HASTA FIN EXISTENCIAS
*WHILE STOCK LAST



≡ Ref. 2345
cm 46 x 16 x 4,5
● Ø 1 cm
≡ Ref. 2348
cm 40 x 16 x 4,5
● Ø 1 cm



≡ Ref. 2314
cm 45 x 19
● Ø 0,8 cm



≡ Ref. 2338
cm 45 x 18
● Ø 0,8 cm
■ 0,5 x 1 cm



≡ **Ref. 2095-C**
cm 48 x 16
○ Ø 1,6 cm

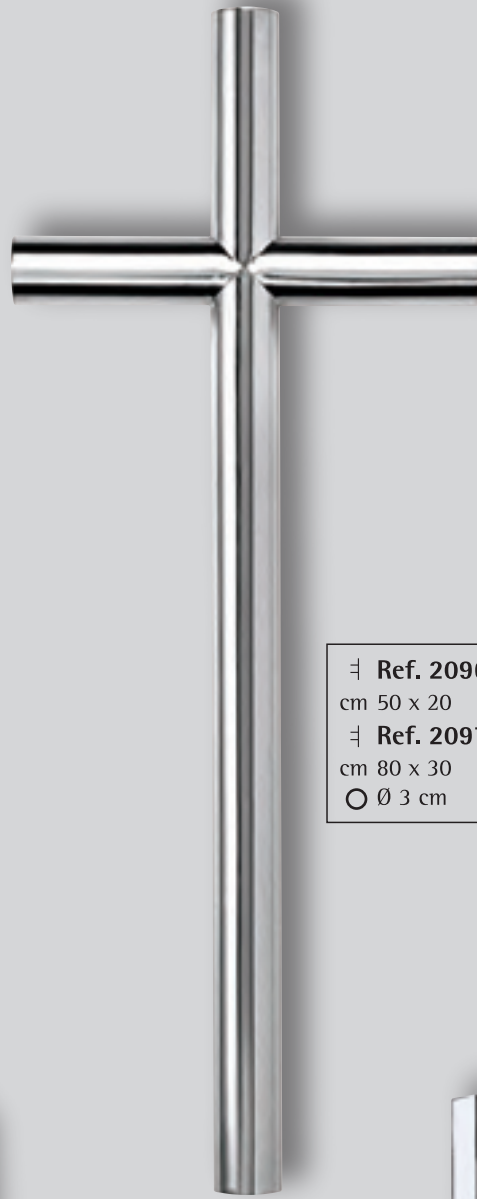

≡ **Ref. 2096**
cm 50 x 20
≡ **Ref. 2097**
cm 80 x 30
○ Ø 3 cm



≡ **Ref. 2313**
cm 48 x 18
● Ø 0,8 cm



≡ **Ref. 2316**
cm 41 x 21
● Ø 0,8 cm

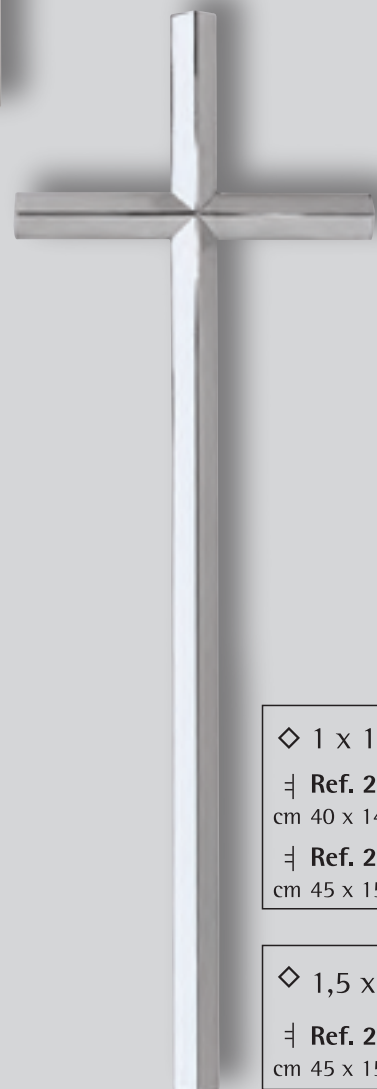

◇ 1 x 1 cm
≡ **Ref. 2055-C**
cm 40 x 14
≡ **Ref. 2055-E**
cm 45 x 15

◇ 1,5 x 1,5 cm
≡ **Ref. 2065-C**
cm 45 x 15



≡ Ref. 2318
cm 40 x 15
● Ø 1 cm



≡ Ref. 2154
cm 40 x 18 x 1,6
● Ø 0,8 cm



≡ Ref. 2310
cm 40 x 14
● Ø 0,8 cm



≡ Ref. 2157
cm 40 x 18
≡ Ref. 2157-25
cm 25 x 13
● Ø 0,8 cm



≡ Ref. 2092-C
cm 35 x 15
≡ Ref. 2092-E
cm 40 x 15
● Ø 1 cm



≡ Ref. 2155
≡ Ref. 2155 C
cm 40 x 18 x 2,5
● Ø 0,8 cm



≡ Ref. 2153
cm 40 x 18 x 3
● Ø 0,8 cm



≡ Ref. 2312
cm 48 x 18
● Ø 0,8 cm



≡ Ref. 2512
cm 60 x 25 x 9
□ 4 x 4 cm
INOX



≡ Ref. 2134 cm 40 x 20 x 3
INOX. 21,5 cm
≡ Ref. 2135 cm 50 x 22 x 5
INOX. 26 cm
■ 3 x 0,5 cm



≡ Ref. 2161
≡ Ref. 2161 C
cm 50 x 21 x 6
● Ø 0,8 cm



≡ Ref. 2330
≡ Ref. 2330 C
cm 48 x 21 x 7
○ Ø 1,6 cm



≡ Ref. 2341
≡ Ref. 2341C
cm 45 x 24 x 5,5
□ 3 x 1,5 cm



≡ Ref. 2347
≡ Ref. 2347C
cm 45 x 24 x 6
□ 3 x 1,5 cm



≡ Ref. 2346
≡ Ref. 2346C
cm 45 x 24 x 6,5
□ 3 x 1,5 cm



≡ Ref. 2210
≡ Ref. 2210C
cm 45 x 20 x 4
□ 2 x 1 cm



≡ Ref. 2109
≡ Ref. 2109C
cm 45 x 20 x 4
□ 2 x 1 cm



≡ Ref. 2211
≡ Ref. 2211C
cm 45 x 20 x 5
□ 2 x 1 cm



Ejemplo / Example
CROMADO
CHROME FINISH



≡ Ref. 2167
≡ Ref. 2167C
cm 40 x 20 x 5
● Ø 0,8 cm



≡ Ref. 2324
≡ Ref. 2324C
cm 40 x 20 x 5
● Ø 0,8 cm



≡ Ref. 2100
≡ Ref. 2100C
cm 48 x 18 x 4
● Ø 0,8 cm



≡ Ref. 2105
≡ Ref. 2105C
cm 40 x 19 x 3,5
● Ø 0,8 cm



≡ Ref. 2156
≡ Ref. 2156C
cm 40 x 20 x 2,5
□ 1 x 2 cm



≡ Ref. 2111
cm 60 x 28 x 7,5
□ 4 x 2 cm



≡ Ref. 2104
cm 51 x 25 x 4
■ 1 x 0,5 cm



≡ Ref. 2115
cm 51 x 21 x 6
■ 0,5 x 1 cm



≡ Ref. 2119
 ≡ Ref. 2119 C
 cm 48 x 20 x 7
 □ 1 x 2 cm



□ 1 x 1 cm
 ≡ Ref. 2121
 ≡ Ref. 2121C
 cm 48 x 18 x 4
 ≡ Ref. 2125
 ≡ Ref. 2125C
 cm 40 x 17 x 4

■ 1 x 0,5 cm
 ≡ Ref. 2123
 ≡ Ref. 2123C
 cm 48 x 18 x 3,5
 ≡ Ref. 2127
 ≡ Ref. 2127C
 cm 40 x 17 x 3,5



≡ Ref. 2308
 ≡ Ref. 2308 C
 cm 48 x 23 x 5
 □ 1 x 2 cm
 ≡ Ref. 5609
 (sólo Cristo/only Christ)
 cm 24 x 21 x 3



Ejemplo / Example
 CROMADO
 CHROME FINISH



≡ Ref. 2319
≡ Ref. 2319C
cm 35 x 15 x 3
● Ø 0,8 cm



≡ Ref. 2306
≡ Ref. 2306C
cm 35 x 12 x 2,5
■ 1 x 0,5 cm



≡ Ref. 2343
≡ Ref. 2343C
cm 35 x 15 x 3
≡ Ref. 2344
≡ Ref. 2344C
cm 45 x 16 x 3
● Ø 0,6 cm



≡ Ref. 2320
cm 35 x 15 x 2,5
INOX.
● Ø 0,8 cm



≡ Ref. 2329
≡ Ref. 2329C
cm 16 x 8,5 x 2,5
■ 1 x 0,5 cm



≡ Ref. 2328
≡ Ref. 2328C
cm 18 x 9 x 2,5
■ 1 x 0,5 cm

≡ Ref. 2321
cm 35 x 15 x 2,5
INOX.
● Ø 0,6 cm

belleza eterna

BELLEZA ETERNA

Desde tiempos inmemoriales el mármol de las Canteras de Macael ha sido utilizado para la construcción de grandes obras, y sus artesanos han elaborado piezas únicas, labradas con sus propias manos para servir de ejemplo y admiración en monumentos históricos.

En Bronces Jordá seleccionamos este mármol, lo reducimos a polvo impalpable y lo mezclamos con resinas convenientemente pasivadas para evitar la acción decolorante del sol y lo compactamos formando esculturas y elementos decorativos tan bellos y valiosos como los realizados con mármol tradicional.

BELEZA ETERNA

Desde os tempos imemoriais, o mármore das Pedreiras de Macael foi utilizado para a construção de grandes obra, e os seus artesãos elaboraram peças únicas, lavradas com as suas próprias mãos para servir de exemplo e admiração em monumentos históricos.

Na Bronces Jordá seleccionamos este mármore, reduzimo-lo a pó impalpável e misturamo-lo com resinas convenientemente apassivadas para evitar a acção descolorante do sol e compactamo-lo, formando esculturas e elementos decorativos tão belos e valiosos como aqueles elaborados com mármore tradicional.

BELLEZZA ETERNA

Da tempi immemorabili, il marmo delle Cave di Macael è stato utilizzato nella costruzione di grandi opere, e gli artigiani responsabili ne hanno ricavato pezzi unici, lavorati con le proprie mani, destinati poi, ad esempi ammirevoli su monumenti storici.

Bronces Jordá seleziona questo marmo e riducendolo in polvere impalpabile e mischiandolo a resine, opportunamente passivate affinché si eviti l'azione decolorante del sole, lo compatta per dare forma a sculture e ad elementi decorativi così belli e preziosi come quelli realizzati mediante il marmo tradizionale.

ETERNAL BEAUTY

Since time immemorial, the marble from the Quarries of Macael has been used to build great works of art. Its skilled artisans have fashioned unique, hand-crafted pieces that serve as much-admired models for historical monuments.

At Bronces Jordá, we select this high-quality marble, reduce it to a very fine dust, mix it with specially treated resins to prevent the discoloring effects of the sun, and compress it to form sculptures and decorative items just as beautiful and valuable as those realized with traditional marble.

BEAUTÉ ÉTERNELLE

Depuis des temps immémoriaux, le marbre des Carrières de Macael a été utilisé dans la construction de grandes œuvres, et ses artisans ont créé des pièces uniques, travaillées de leurs propres mains, afin de servir d'exemple et susciter de l'admiration pour des monuments historiques.

Chez Bronces Jordá, nous sélectionnons ce marbre, le réduisons en poudre très fine et le mélangeons avec des résines convenablement passivées afin d'éviter l'action décolorante du soleil, puis nous le compactons pour créer des sculptures et des objets de décoration aussi beaux et d'une aussi grande valeur que ceux réalisés à partir du marbre traditionnel.

EEUWIGE SCHOONHEID























Al sinds mensenheugenis wordt het marmer uit de steengroeven van Macael aangewend in belangrijke bouwwerken, en handwerkslieden hebben er unieke kunstwerken mee vervaardigd die nog steeds te bewonderen zijn in vele historische monumenten.





Bij Bronces Jordá selecteren wij marmer, we vermaleren het tot vederlicht poeder en we vermengen het met op passende wijze gepassificeerd hars om te voorkomen dat het door de zon verkleurt, we gieten het in de compacte vorm van sculpturen en andere decoratieve elementen die even mooi en waardevol zijn als waren ze uitgevoerd in traditioneel marmer.

mármol reconstituido

reconstituted marble



	D 228 - 283 - 284 - 285
	O 224 - 225 - 226 - 227 - 228 - 229 - 230 - 231
	D 287
	D 290 - 291
	O 248 - 249 - 290
	D 261 - 262
	D 271 - 272
	D 287
	O 250
	D 256 - 257 - 258 - 259
	O 242 - 243
	D 272
	O 238
	D Cristo de Medinaceli 283 251 - 252 - 253
	O Cristo de Medinaceli 243
	D 254 - 255
	O 255
	D 254 - 255
	D 290 - 291
	O 249
	D 286 - 287
	D 291 - 292 - 293
	O 249
	D 289
	O 233 - 234 - 235
	O 246 - 247
	D 286
	D 293
	D 286
	D 279 - 280 - 281
	O 232 - 233

	D 288
	D 287
	S. Agustín, S. Andrés 275 S. Antonio, S. Antonio Abad 275 S. Blas, S. Cristóbal 276 D S. Enrique, S. Francisco 276 S. Joaquín, S. Jorge 276 S. José 277 S. Juan, S. Luis, S. Miguel 278 S. Pedro, S. Rafael, S. Ramón 278 Sto. Tomás de Aquino, S. Vicente 279
	O S. Antonio, S. José 244 S. Francisco, S. Miguel 244 S. Padre Pio, S. Patricio 245
	V. Angustias, V. Begoña 267 V. Cabeza, V. Covadonga 267 V. Carmen 264, 265, 266 V. Desamparados, V. Esperanza Macarena 267 V. Dolorosa 270 D V. Lourdes, V. María Auxiliadora 268 V. Milagrosa, V. Montserrat 268 V. Niña 273 - 274 V. Pilar, V. Purísima 269 V. Rosario, V. Rocío 270 Sta. Rita, Sta. Rosa, Sta. Teresa 274
	V. Carmen 236 V. Fátima, V. Guadalupe 238 O V. Inmaculada 237 V. Lourdes 239 - 240 V. Niña 241 - 246 V. Purísima 240 - 241 Sta. Ana 241 Sta. Bernardette 240 Sta. Rita, Sta. Teresa 241
	Arcadas 287, Cinta 282 Concha 286, El Paso 262 El Entierro 282 D Mariposa 286 Nazareno 260 - 262 Oración del Huerto 283 Osito 286 Sagrada Familia 282 - 283 Vía Crucis 263
	O Buen Pastor 243 Cristo con ángel 231 Cristo arrodillado 244 Juan Pablo II 245 - 246 Nazareno 245 Niño dormido 246 Redentor 243 Resurrección 235

ACABADOS NORMALIZADOS STANDART FINISHES

Las esculturas de mármol reconstituido podemos suministrarlas en cualquiera de los acabados que les mostramos, con la excepción del "negro pulido" en el que sólo fabricamos unos pocos y concretos artículos.

Para evitar dar a esta sección un excesivo volumen, sólo detallaremos las referencias correspondientes al acabado en el que se muestra cada artículo. Para identificar o pedir los productos con diferente acabado sólo será necesario añadir a su número de referencia la letra correspondiente.

Están disponibles para entrega inmediata todos los artículos en el acabado que muestran sus fotografías y en los que indican los cuadrados en el color y su letra correspondiente.

As esculturas de mármore reconstituido podemos fornecelas nos diferentes tipos de acabamento que lhe mostramos, com a excepção do "negro pulido" porque só o fabricamos em muito poucos e concretos artigos.

Para evitar dar esta secção do catálogo um excessivo volume só detalhamos as referências correspondentes ao acabamento que se mostra em cada artigo, para identificar ou pedir qualquer escultura com um acabamento diferente só é necessário juntar ao número a letra que corresponde ao acabamento. Estão disponíveis para entrega imediata todos os artigos com acabamento que se expie e nos que indicam os quadrados com a cor e letra correspondente.

Possiamo fornire le sculture di marmo ricostruito in qualsiasi di quelle rifiniture indicate, con l'eccezione del "negro pulido", di quale soltanto produciamo alcuni e molto concreti articoli.

Per evitare di dare a questa sezione del catalogo un volume eccessivo, detaglieremo soltanto le referenze che corrispondono a quella rifinitura di ogni articolo.

Per identificare o ordinare qualsiasi scultura con rifinitura diferente, è necessario soltanto da aggiungere la lettera corrispondente al relativo numero di referenza.

Sono disponibili, per la consegna immediata, tutti gli articoli nella stessa finitura della propria foto, e anche gli articoli nel colore e lettera indicati nel riquadro.



Acabado
Blanco Barnizado S
Ref. 7483 S

Acabado Blanco □
Ref. 6156



Acabado
Bronce Barnizado B
Ref. 6156 B

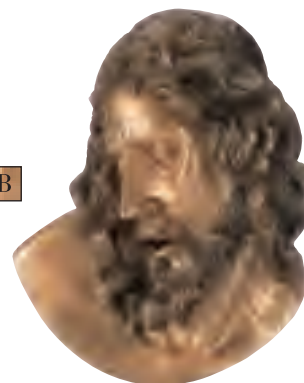

Acabado Plateado A
Ref. 6156 A



Acabado Negro N
Ref. 6156 N



The sculptures made in reconstituted marble can be made in any of standard finishes we offer with the exception of "negro pulido", because in this finish we only make a few concrete articles.

In order to avoid giving an excessive volume we detail only the reference numbers in accord with the finish found in catalogue. To identify and order any article with different finish it will be necessary to add the identifying final letter.

This range of sculptures is available for immediate delivery in finished shown in catalogue and also in the finishes shown in squares with their corresponding colour and letter.

Acabado Negro Pulido P
Ref. 6226 P



*mármol
reconstituido*



Ref. 7001
cm 175 x 75 x 66
cm 50 x 60

B

*mármol
reconstituido*



Ref. 7003
cm 181 x 94 x 75
cm 42 x 37

B



♀ Ref. 7889 **B**
cm 99 x 45 x 27
☐ 32 x 18 cm



♀ Ref. 6900 **B**
cm 107 x 55 x 33
☐ 35 x 33 cm



♀ Ref. 6902 **B**
cm 107 x 49 x 33
☐ 23 x 23 cm



♀ Ref. 7277 **B**
cm. 80 x 36 x 20
☐ 34 x 20 cm.
♀ Ref. 7278 **B**
cm. 106 x 40 x 26
☐ 33 x 21 cm.



♀ Ref. 6051
cm 70 x 29 x 23
☐ 20 x 17 cm

B



♀ Ref. 7280
cm 67 x 22 x 24
☐ 16 x 16 cm

B

♀ Ref. 7281
cm 105 x 35 x 31
☐ 26 x 20 cm

B



♀ Ref. 7347
cm 63 x 22 x 15
☐ 15 x 15 cm

B



♀ Ref. 6041
cm 64 x 21 x 20
☐ 15 x 15 cm

B



♀ Ref. 6049
cm 62 x 20 x 24
☐ 18 x 16 cm

B



♀ Ref. 7348
cm 38 x 14 x 12
☐ 12 x 12 cm

B



Q Ref. 7358
cm 48 x 24
☐ Ø 24 cm



Q Ref. 6059 B
cm 42 x 15 x 7
☐ 10 x 10 cm



Q Ref. 6057 B
cm 42 x 15 x 7
☐ 10 x 10 cm

Q Ref. 6482 B
cm 29 x 12 x 11
☐ 7 x 7 cm



Q Ref. 6061 B
cm 57 x 24 x 16
☐ 16 x 14 cm



Q Ref. 7339 B
A
cm 13,5 x 8 x 7
☐ 6 x 3,5 cm



Q Ref. 7340 B
A
cm 10 x 8 x 7,5
☐ 7 x 5 cm



D Ref. 7338 B
A
cm 7 x 15 x 7,5



♀ **Ref. 7359** **B**
cm 25 x 10 x 9
☐ 5,5 x 6 cm
♀ **Ref. 7360** **B**
cm 46 x 19 x 15,5
☐ 11 x 11 cm



♀ **Ref. 7343** **B**
cm 30 x 14,5 x 14,5
☐ 8 x 8 cm



♀ **Ref. 7344** **B**
cm 45 x 21 x 21
☐ 12 x 12 cm

♀ **Ref. 7349** **B**
cm 50 x 36 x 25
☐ 14,5 x 14 cm



♀ **Ref. 6484**
cm 25 x 12 x 7
☐ 7 x 7 cm



♀ **Ref. 6043** **B**
cm 30 x 11 x 9
☐ 7,5 x 7,5 cm

♀ **Ref. 7345** **B**
cm 26 x 8 x 9
☐ 6 x 6 cm
♀ **Ref. 7346** **B**
cm 35 x 11 x 10
☐ 9 x 7 cm





♀ Ref. 7350
cm 25 x 13
♁ 10 x 17 cm

B

♀ Ref. 7352
cm 38 x 16
♁ 13 x 22 cm

B



♀ Ref. 7351
cm 25 x 13
♁ 10 x 17 cm

B

♀ Ref. 7353
cm 38 x 16
♁ 13 x 22 cm

B



♀ Ref. 7355
cm 19 x 10 x 11
7 x 9,5 cm

B



♀ Ref. 7354
cm 19 x 10 x 11
7 x 9,5 cm

B



♀ Ref. 6064
cm 27 x 14 x 16
♁ 10 x 15 cm

B

♀ Ref. 6065
cm 27 x 14 x 16
♁ 10 x 15 cm

B



mármol
reconstituido



Ref. 6251
↔ ↑ ↘
cm 75 x 68 x 37
↔ 68 x 37 cm

Ref. 6252
↔ ↑ ↘
cm 132 x 117 x 55
↔ 117 x 53,5 cm



PIEDAD DE MIGUEL ÁNGEL

♀ Ref. 7424
cm 19 x 15 x 7
♂ 15 x 17 cm

B

♀ Ref. 7423
cm 42 x 35 x 15
♂ 35 x 15 cm

B

♀ Ref. 7425
cm 53 x 36 x 20
♂ 36 x 20 cm

B

♀ Ref. 7426
cm 70 x 55 x 31
♂ 54 x 22 cm

B

A

♀ Ref. 7428
cm 106 x 75 x 47
♂ 65 x 42 cm

B



PIEDAD

♀ Ref. 7420
cm 87 x 32 x 25
♂ 30 x 23 cm

B



♀ Ref. 6075
cm 66 x 60 x 40
♂ 60 x 40 cm

B



OFRENDA

♀ Ref. 7467
cm 81 x 35 x 60
♂ 30 x 60 cm

B



♀ Ref. 6904
cm 88 x 28 x 23
♂ 23 x 23 cm



♀ Ref. 7478
cm 70 x 35 x 45
♂ 35 x 46 cm

B



♀ Ref. 7474
cm 150 x 35 x 76
♂ 52 x 32 cm

B



♀ Ref. 7476
cm 75 x 21 x 46
☞ 18 x 30 cm



♀ Ref. 7362
cm 50 x 26 x 17,5
☞ 26 x 17,5 cm

B



♀ Ref. 7472
cm 49 x 23,5 x 43
☞ 23,5 x 30 cm



♀ Ref. 7418
cm 72 x 69 x 20
☞ 51 x 15 cm



VIRGEN DEL CARMEN

♀ Ref. 6450
cm 80 x 27 x 18
☞ 17 x 15 cm

B

A



VIRGEN DEL CARMEN

♀ Ref. 7033
cm 60 x 17 x 12
☞ 13 x 13 cm

B

♀ Ref. 7036
cm 80 x 28 x 22
☞ 21 x 21 cm

B

A

♀ Ref. 7038
cm 125 x 37 x 33
☞ 30 x 27 cm

B



VIRGEN DEL CARMEN

♀ Ref. 6650
cm 50 x 16 x 13
☞ 13 x 13 cm

B



♀ Ref. 6737
cm 27 x 17
☞ Ø 17 cm



VIRGEN DEL CARMEN

♀ Ref. 6648
cm 25,5 x 7 x 6,5
☞ 6,5 x 6,5 cm

B



INMACULADA

♀ Ref. 7483

cm 42 x 17 x 10
☞ 9,5 x 9,5 cm

B A

♀ Ref. 7484

cm 52 x 23 x 13,5
☞ 13,5 x 13,5 cm

B

♀ Ref. 7480

cm 120 x 47 x 30
☞ 28 x 28 cm



INMACULADA

♀ Ref. 7487

cm 73 x 30 x 21
☞ Ø 20 cm

B

♀ Ref. 7488

cm 96 x 39 x 26
☞ Ø 25 cm

♀ Ref. 7489

cm 117 x 46 x 33
☞ Ø 30 cm



INMACULADA

♀ Ref. 7482

cm 30 x 12,5 x 8
☞ 9 x 8 cm

B



INMACULADA

♀ Ref. 7485

cm 77 x 35 x 20
☞ 20 x 20 cm



INMACULADA

♀ Ref. 7486

cm 115 x 46 x 25
☞ 23 x 22 cm



CORAZÓN DE MARÍA

Q Ref. 7294
cm 98 x 32 x 29
B 22 x 20 cm



CORAZÓN DE MARÍA

Q Ref. 7292
cm 84 x 28 x 25
B 20 x 20 cm



CORAZÓN DE MARÍA

Q Ref. 7290
cm 72 x 23 x 14
B 16 x 16 cm



VIRGEN DE FÁTIMA

Q Ref. 7118
cm 95 x 30 x 33
B 24 x 20 cm



VIRGEN DE FÁTIMA

Q Ref. 7116
cm 60 x 21 x 13,5
B 13,5 x 13,5 cm

VIRGEN DE
GUADALUPE

Q Ref. 7205
cm 80 x 30,5 x 19
B 16 x 15,5 cm





VIRGEN DE LOURDES

Q Ref. 7072
cm 105 x 28 x 28
cm 27 x 27 cm

B

Q Ref. 7076
cm 168 x 45 x 39
cm 43 x 43 cm



STA. BERNARDETTE

 **Ref. 7074**
 cm 35 x 12 x 18
 12 x 18 cm

B



VIRGEN DE LOURDES

 **Ref. 7070**
 cm 39 x 11 x 11
 9,5 x 10 cm

B

A

 **Ref. 7071**
 cm 52 x 15 x 12
 12 x 12 cm

B

 **Ref. 7060**
 cm 62 x 19 x 15,5
 14 x 14,5 cm

B

 **Ref. 7073**
 cm 76 x 22 x 17
 17 x 17 cm

B



VIRGEN DE LOURDES

 **Ref. 7069**
 cm 22 x 6 x 6
 5,5 x 5,5 cm

B

 **Ref. 7068**
 cm 34 x 9 x 9
 9 x 9 cm

B

A



VIRGEN PURÍSIMA

 **Ref. 7142**
 cm 118 x 36 x 27
 28 x 27 cm

B



VIRGEN PURÍSIMA

 **Ref. 7138**
 cm 50 x 20 x 18
 20 x 14 cm

B





♀ Ref. 7015
cm 89 x 31 x 15
☐ 20 x 20 cm



VIRGEN NIÑA

♀ Ref. 7013
cm 65 x 16 x 11
☐ 10 cm

B



VIRGEN NIÑA

♀ Ref. 6117
cm 65 x 15 x 15
☐ 11 x 15 cm

B



SANTA RITA

♀ Ref. 7086
cm 60 x 18 x 15
☐ 14 x 13 cm

B



VIRGEN PURÍSIMA

♀ Ref. 7140
cm 80 x 22 x 22
☐ 18 x 18 cm

B



SANTA ANA

♀ Ref. 7084
cm 60 x 22 x 17
☐ 20 x 15 cm

B

SANTA TERESA

♀ Ref. 7082
cm 30 x 9 x 8,5
☐ 8 x 7,5 cm

B

♀ Ref. 7083
cm 40 x 13,5 x 12
☐ 11 x 11,5 cm

B

♀ Ref. 7085
cm 60 x 19 x 15
☐ 14 x 15 cm

B



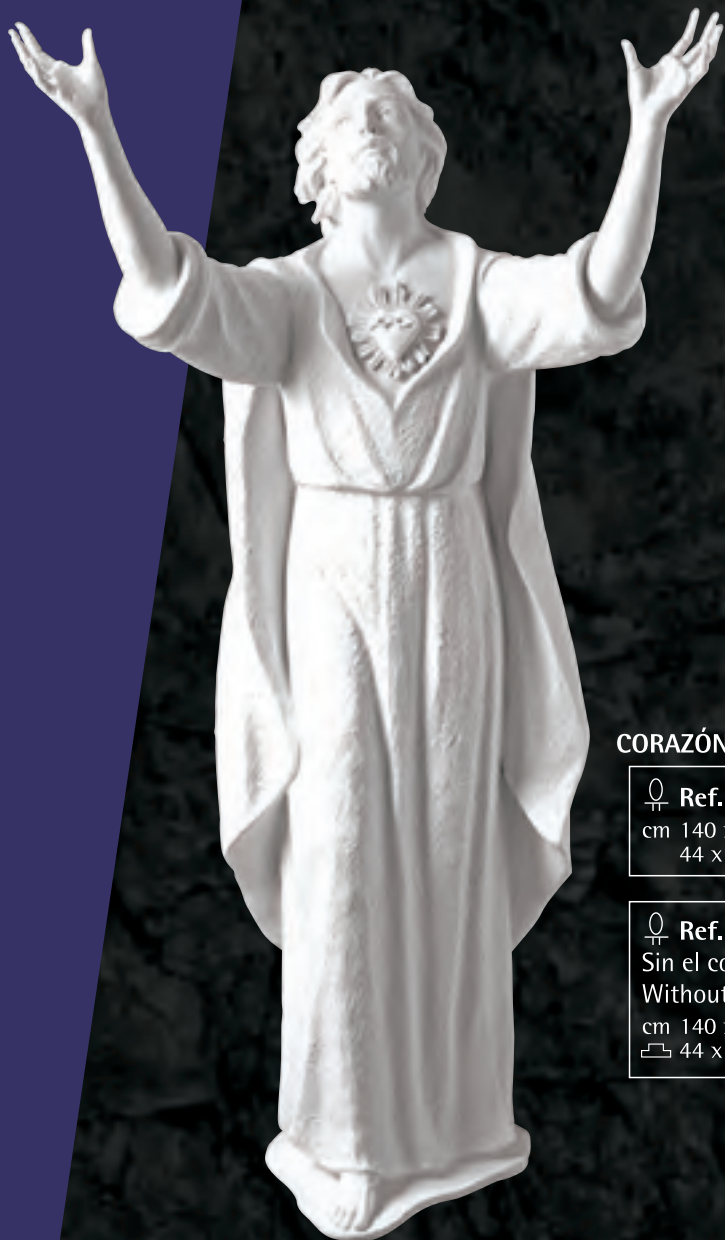

CORAZÓN DE JESÚS

♀ Ref. 7172
cm 140 x 74 x 47
44 x 30 cm

♀ Ref. 7173
Sin el corazón
Without heart
cm 140 x 74 x 47
44 x 30 cm



CORAZÓN DE JESÚS

♀ Ref. 7162
cm 85 x 38 x 33
21 x 20 cm

B



CORAZÓN DE JESÚS

♀ Ref. 6109
cm 57 x 30 x 24
Ø16 cm

B



CORAZÓN DE JESÚS

♀ Ref. 7161
cm 82 x 48 x 30
Ø 20 cm

♀ Ref. 7163
cm 108 x 60 x 37
Ø 27 cm

B



CORAZÓN DE JESÚS

♀ Ref. 7164
cm 62 x 21 x 13
♂ 12 x 10 cm

♀ Ref. 7166
cm 95 x 35 x 22
♂ 21 x 20 cm

B



CORAZÓN DE JESÚS

♀ Ref. 7150
cm 20 x 7 x 4,5
♂ 4,5 x 4,5 cm

♀ Ref. 7152
cm 28 x 10 x 6,5
♂ 6,5 x 6,5 cm

♀ Ref. 7153
cm 40 x 14 x 10,5
♂ 9,5 x 10 cm

♀ Ref. 7154
cm 50 x 17 x 13
♂ 11 x 10 cm

♀ Ref. 7155
cm 75 x 23 x 17
♂ 17 x 17 cm

♀ Ref. 7156
cm 82 x 28 x 22
♂ 19 x 16 cm

♀ Ref. 7158
cm 96 x 33 x 26
♂ 24 x 20 cm

♀ Ref. 7160
cm 122 x 40 x 28
♂ 26 x 26 cm

B

B

B

B

B

B

B

B



CRISTO DE MEDINACELI

♀ Ref. 7170
cm 92 x 29 x 25,5
♂ 27 x 25,5 cm



BUEN PASTOR

♀ Ref. 7436
cm 80 x 28 x 20
♂ 22 x 19 cm



CORAZÓN DE JESÚS

♀ Ref. 6460
cm 73 x 29 x 22
♂ 18 x 18 cm

B



REDENTOR

♀ Ref. 7229
cm 86 x 26 x 24
♂ 23 x 24 cm



♀ Ref. 7169
cm 100 x 76 x 54
♂ 45 x 54 cm



SAN JOSÉ

♀ Ref. 7126
cm 78 x 30 x 20
♂ 20 x 19 cm
♀ Ref. 7129
cm 169 x 59 x 48
♂ 43 x 43 cm

B



SAN ANTONIO

♀ Ref. 7232
cm 20 x 7 x 5
♂ 5 x 5 cm
♀ Ref. 7234
cm 39 x 13 x 10
♂ 9 x 9 cm
♀ Ref. 7236
cm 75 x 27 x 20
♂ 16 x 16 cm
♀ Ref. 7238
cm 105 x 32 x 24
♂ 24 x 20 cm

B

B

A

B

B



SAN MIGUEL

♀ Ref. 7438
cm 58 x 24 x 17
♂ 17 x 16 cm

B

SAN JOSÉ

♀ Ref. 7120
cm 21 x 7 x 5,5
♂ 6 x 6 cm
♀ Ref. 7122
cm 45 x 16 x 11
♂ 13 x 11 cm
♀ Ref. 7124
cm 59 x 21 x 17
♂ 15 x 14 cm

B

B

B





SAN PATRICIO

♀ Ref. 6960
cm 60 x 22 x 22,5
♂ 18 x 22 cm

B



JUAN PABLO II

♀ Ref. 6951
cm 64 x 23 x 23
♂ 19 x 19 cm



SAN FRANCISCO

♀ Ref. 7440
cm 85 x 40 x 30
♂ 26 x 24 cm

B



SAN PADRE PÍO

♀ Ref. 7240
cm 60 x 22 x 16,5
♂ 18,5 x 16,5 cm

B

A



NAZARENO

♀ Ref. 7430
cm 59 x 33 x 16
♂ 24 x 16 cm

B



♀ Ref. 6189
cm 19 x 12 x 8
☐ 8,5 x 5,5 cm



♀ Ref. 7270
cm 14 x 10 x 7

B



JUAN PABLO II

♀ Ref. 7272
cm 22 x 15 x 8
☐ 8 cm

♀ Ref. 7342
cm 30 x 9,5 x 11
☐ 8 x 8 cm

B

♀ Ref. 7341
cm 45 x 14 x 16
☐ 12 x 12 cm

B



♀ Ref. 8212
↔ ↑ ↘
cm 20 x 18 x 12
☐ 20 x 12 cm

♀ Ref. 6500
↔ ↑ ↘
cm 26 x 19 x 15
☐ 12 x 8,5 cm

B

A

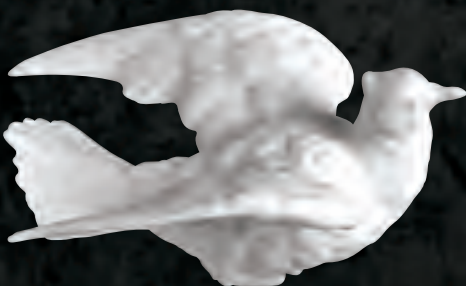

♀ Ref. 6586
↔ ↑ ↘
cm 17 x 7 x 12

B

♀ Ref. 8214
↔ ↑ ↘
cm 13 x 8,5 x 8

♀ Ref. 6498
↔ ↑ ↘
cm 15,5 x 9,5 x 22



♀ Ref. 6580
 ↔ 22 cm
 ↓ 13 cm
 ↘ 13 cm
 ⊞ 5 x 4 cm



♀ Ref. 6582 **B**
 ↔ 21 cm
 ↓ 16 cm
 ↘ 11 cm
 ⊞ 5 x 5 cm



♀ Ref. 6590 **B**
 ↔ 14 cm
 ↓ 9 cm
 ↘ 8 cm



♀ Ref. 6581 **B**
 ↔ 23 cm
 ↓ 23 cm
 ↘ 25 cm
 ⊞ 10 x 11 cm **A**

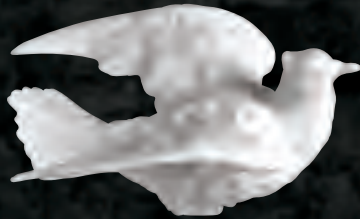

♀ Ref. 6589 **B**
 ↔ 12 cm
 ↓ 5 cm
 ↘ 8 cm



♀ Ref. 6587
 ↔ 13 cm
 ↓ 5 cm
 ↘ 10 cm
 ♀ Ref. 6588 **B**
 ↔ 10 cm
 ↓ 4 cm
 ↘ 7 cm



♀ Ref. 6591 **B**
 ↔ 16 cm
 ↓ 10 cm
 ↘ 7 cm



♀ Ref. 6583 **B**
 ↔ 12 cm
 ↓ 8 cm
 ↘ 7 cm
 la pareja/pair



♀ Ref. 6585 **B**
 ↔ 21 cm
 ↓ 16 cm
 ↘ 11 cm
 ⊞ 5 x 5 cm



♀ Ref. 6584 **B**
 ↔ 21 cm
 ↓ 16 cm
 ↘ 11 cm
 ⊞ 5 x 5 cm



Ref. 6452
cm 48 Ø 23
20 x 20 cm
D 88

B



Ref. 6205 B
cm 46 Ø 23
20 x 20 cm
D 88

■



Ref. 6454
cm 49 Ø 24
20 x 20 cm
D 88

B



Ref. 6211B
cm 34 Ø 14
12 x 12 cm
D 86

■



Ref. 6207
cm 24 Ø 12
10 x 10 cm
D 84

B



Ref. 6213
cm 24 Ø 12
9,5 x 9,5 cm
D 84

B



Ref. 6209
cm 29 Ø 13
11 x 11 cm
D 86

B



Ref. 6215
cm 18 Ø 8
7 x 7 cm
D 82

B



♀ Ref. 7869
cm 28 x 17 x 17
♂ 13 x 13 cm
▽ D 86



♀ Ref. 7864 **B**
cm 28 Ø 17
♂ 12 x 12 cm
▽ D 86



♀ Ref. 7862 **B**
cm 22 Ø 14
♂ 11 x 11 cm
▽ D 84



♀ Ref. 6446 **B**
cm 35 Ø 15
♂ 13 x 13 cm
▽ D 86



♀ Ref. 6464 **B**
cm 54 x 18 x 17
♂ 40 x 10 cm



♀ Ref. 6462 **B**
cm 28 x 14 x 17
♂ 17 x 8 cm



♀ Ref. 7866
cm 23 Ø 11
♂ 10 x 10 cm
▽ D 84



♀ Ref. 6217 **B**
cm 22 Ø 11
♂ Ø 8 cm
▽ V1



♀ Ref. 6173
cm 18 x 11
♂ Ø 7,5 cm
▽⊗ RD 97C



Ref. 6229
cm 60
10 x 10 cm



Ref. 6221
cm 51
11 x 11 cm



Ref. 7504
cm 95
21 x 21 cm



Ref. 7506
cm 69
24 x 24 cm



Ref. 7502
cm 70
21 x 21 cm

B



Ref. 6227
cm 75 x 50 x 12



Ref. 6225
cm 93 x 72 x 15

B



Ref. 6220
cm 68 x 51 x 15

N



Ref. 6218
cm 53 x 47 x 13

B



⇒ Ref. 6239
cm 47 x 40 x 10

B
N



⇒ Ref. 6243
cm 46 x 33 x 9



⇒ Ref. 6222
cm 37 x 26 x 6

B
N



⇒ Ref. 6216
cm 46 x 37 x 8



⇒ Ref. 6644
cm 45 x 23 x 5

B
N



⇒ Ref. 6214
cm 31 x 26 x 8

N



⇒ Ref. 6212
cm 30 x 19 x 6



⇒ Ref. 6208
cm 27 x 21 x 3



⇒ Ref. 6241
cm 26 x 16 x 4



⇒ Ref. 6210
cm 24 x 14 x 5

A
N



⇒ **Ref. 6184**

cm 123 x 66 x 19

⇒ **Ref. 6183 Sólo cruz/Only cross**

cm 123 x 66 x 5



Ref. 6185
cm 101 x 58 x 10
9 x 9 cm

B



Ref. 6182
cm 60 x 33 x 10

N



Ref. 6186
cm 39 x 15 x 3



Ref. 6916
cm 12 x 6,5 x 1



Ref. 6178
cm 43 x 20 x 6



CORAZÓN DE JESÚS

Ref. 6090
cm 39 x 26 x 6

B

N

Ref. 6092
cm 33 x 24 x 6

N



CORAZÓN DE JESÚS

Ref. 6341
cm 50 x 18 x 7

B



CORAZÓN DE JESÚS

Ref. 6335
cm 67 x 26 x 12

B



CORAZÓN DE JESÚS

Ref. 6495
cm 37 x 14 x 4

N



CORAZÓN DE JESÚS

Ref. 6104
cm 36 x 13 x 7

B

N



CORAZÓN DE JESÚS

Ref. 6094
cm 36 x 17 x 7

B

A

N



CORAZÓN DE JESÚS

⇒ Ref. 6106
cm 32 x 12 x 4

B
N



CORAZÓN DE JESÚS

⇒ Ref. 6098
cm 34 x 27 x 8



CORAZÓN DE JESÚS

⇒ Ref. 6096
cm 34 x 17 x 6

B



CORAZÓN DE JESÚS

⇒ Ref. 6330
cm 30 x 22 x 7

A
N



⇒ Ref. 6320
cm 36 x 16 x 7

B
N



CORAZÓN DE JESÚS

⇒ Ref. 7319
cm 29 x 24 x 5

B
N



CORAZÓN DE JESÚS

⇒ Ref. 6088
cm 42 x 34 x 6

B A
N



CORAZÓN DE JESÚS

⇒ Ref. 6102
cm 30 x 26 x 9

A
N



CORAZÓN DE JESÚS

⇒ Ref. 6086
cm 49 x 28 x 7

B
N



CORAZÓN DE JESÚS

Ref. 6646 **B**
cm 27 x 16 x 5 **A**



CORAZÓN DE JESÚS

Ref. 7011
cm 17 x 15 x 4



CORAZÓN DE JESÚS

Ref. 6412 **B**
cm 22 x 14 x 6



CORAZÓN DE JESÚS

Ref. 6708
cm 18 x 13 x 2



CORAZÓN DE JESÚS

Ref. 6110 **B**
cm 38 x 35 x 6 **N**



CORAZÓN DE JESÚS

Ref. 6413 **B**
cm 14 x 11 x 5



NAZARENO

⇒ Ref. 6132
cm 35 x 29 x 7

B A
N



NAZARENO DEL GRAN PODER

⇒ Ref. 6421
cm 35 x 21 x 7

B
N



NAZARENO DEL ARCO

⇒ Ref. 6133
cm 43 x 22 x 5



NAZARENO DEL GRAN PODER

⇒ Ref. 6419
cm 39 x 21 x 7

B
A



NAZARENO DEL GRAN PODER

⇒ Ref. 6420
cm 35 x 21 x 7

B
A



ÓVALO CRISTO

⇒ Ref. 6416
cm 34 x 28 x 5

B
N



CABEZA DE CRISTO

⇒ Ref. 6744
cm 28 x 23 x 4

B A
N



MEDALLÓN CRISTO

⇒ Ref. 6165
cm Ø 22 x 5

N



CABEZA DE CRISTO

⇒ Ref. 6154
cm 34 x 26 x 10



CABEZA DE CRISTO

⇒ Ref. 6156
cm 28 x 22 x 8

B A
N



ECCE HOMO

⇒ Ref. 6159
cm Ø 19 x 5



MEDALLÓN CRISTO

⇒ Ref. 6529
cm Ø 18 x 7



CABEZA DE CRISTO

⇒ Ref. 6528
cm 12 x 11 x 5

B



ROSTRO CRISTO

⇒ Ref. 6720
cm 23 x 23 x 3



MEDALLÓN CRISTO

⇒ Ref. 6160
cm Ø 10 x 3

B

⇒ Ref. 6162
cm Ø 14 x 3

B

⇒ Ref. 6164
cm Ø 21 x 4



MEDALLÓN CRISTO

⇒ Ref. 6716
cm Ø 15 x 5

⇒ Ref. 6718
cm Ø 20 x 9



ECCE HOMO

⇒ Ref. 6150
cm Ø 27 x 8



MEDALLÓN NAZARENO

⇒ Ref. 6712
cm Ø 14 x 4

⇒ Ref. 6714
cm Ø 19 x 5



BUSTO DE CRISTO

⇒ Ref. 7149
cm 31 x 21 x 11



EL PASO

⇒ Ref. 6130
cm 55 x 44 x 8

B



VIA CRUCIS (14 estaciones)

Ref. 6188
Ref. 6188 B
cm 22 x 22 x 4





VIRGEN DEL CARMEN

⇒ Ref. 6332 **B**
cm 56 x 23 x 6 **A**



VIRGEN DEL CARMEN

⇒ Ref. 6333 **B**
cm 65 x 25 x 10 **A**



VIRGEN DEL CARMEN

⇒ Ref. 6494
cm 42 x 14 x 6



VIRGEN DEL CARMEN

⇒ Ref. 6021 **B** **A**
cm 42 x 14 x 8 **N**



VIRGEN DEL CARMEN

⇒ Ref. 6023 **A**
cm 35 x 13 x 7 **N**



VIRGEN DEL CARMEN

⇒ Ref. 6016
cm 34 x 13 x 3

B A
N



VIRGEN DEL CARMEN

⇒ Ref. 6024
cm 33 x 13 x 6

B A
N



VIRGEN DEL CARMEN

⇒ Ref. 6020
cm 37 x 15 x 8

B A
N



VIRGEN DEL CARMEN

⇒ Ref. 6642
cm 24 x 12 x 4

B



VIRGEN DEL CARMEN

⇒ Ref. 6018
cm 32 x 19 x 6

B A



VIRGEN DEL CARMEN

⇒ Ref. 6383
cm 15 x 11 x 4

B
A



VIRGEN DEL CARMEN

⇒ Ref. 6444
cm 36 x 29 x 10

B
N



VIRGEN DEL CARMEN

⇒ Ref. 6370
cm 33 x 29 x 3



VIRGEN DEL CARMEN

⇒ Ref. 6382
cm 21 x 15 x 4

B



VIRGEN DEL CARMEN

⇒ Ref. 6445
cm 40 x 23 x 9

B A
N



VIRGEN DEL CARMEN

⇒ Ref. 6447
cm 30 x 23 x 9

B A



VIRGEN DE LAS ANGUSTIAS

⇒ Ref. 6430
cm 28 x 16 x 4

B



VIRGEN DE BEGOÑA

⇒ Ref. 6576
cm 24 x 12 x 5

B A

⇒ Ref. 6574
cm 24 x 12 x 8



VIRGEN DE LA CABEZA

⇒ Ref. 6728
cm 35,5 x 26 x 7

B A

N



VIRGEN DE COVADONGA

⇒ Ref. 6578
cm 31 x 17,5 x 6

B



VIRGEN DE LOS DESAMPARADOS

⇒ Ref. 6030
cm 32 x 18 x 7

B A N

⇒ Ref. 6029
cm 37 x 20 x 7,5

B A N



ESPERANZA MACARENA

⇒ Ref. 6739
cm 30 x 17 x 5

B

A



MARÍA AUXILIADORA

⇒ Ref. 6022
cm 34 x 14 x 7

B A
N



VIRGEN DE LOURDES

⇒ Ref. 6329
cm 51 x 16 x 7,5
⇒ Ref. 6331
cm 74 x 23 x 12

B
B



MARÍA AUXILIADORA

⇒ Ref. 6392
cm 36 x 13 x 6

B



MILAGROSA

⇒ Ref. 6152
cm 42 x 12 x 3,5

B
A



VIRGEN DE MONTSERRAT

⇒ Ref. 6736
cm 22 x 14 x 5



VIRGEN DE MONTSERRAT

⇒ Ref. 6296
cm 36 x 20 x 3



VIRGEN DEL PILAR

⇒ Ref. 6033
cm 37 x 19 x 8

B A
N



BUSTO VIRGEN DEL PILAR

⇒ Ref. 6298
cm 29 x 8 x 6

B
B N



VIRGEN DEL PILAR

⇒ Ref. 6032
cm 34 x 19 x 8

B N



PURÍSIMA

⇒ Ref. 6012
cm 37 x 22 x 7

B N



PURÍSIMA

⇒ Ref. 6486
cm 22 x 14 x 6

B



PURÍSIMA

⇒ Ref. 6014
cm 36 x 16 x 8

B A
N



VIRGEN DEL ROSARIO

⇒ Ref. 6010
cm 37 x 13 x 9

B A
N



NTRA. SRA. DEL ROCÍO

⇒ Ref. 6424
cm 34 x 22 x 7

B
A



DOLOROSA

⇒ Ref. 6000
cm 37 x 11 x 4

B



DOLOROSA

⇒ Ref. 6002
cm 26 x 24 x 5

B A
N



DOLOROSA

⇒ Ref. 6378
cm 29 x 26 x 3



MEDALLÓN DOLOROSA

⇒ Ref. 6171
cm Ø 22 x 6

N



MEDALLÓN DOLOROSA

⇒ Ref. 7630
cm Ø 15 x 5
⇒ Ref. 7632
cm Ø 20 x 7

B



MEDALLÓN DOLOROSA

⇒ Ref. 6168
cm Ø 14 x 3
⇒ Ref. 6170
cm Ø 21 x 4

B



⇒ Ref. 6523
cm Ø 21 x 5



⇒ Ref. 6525
cm Ø 18 x 6



MEDALLÓN DOLOROSA

⇒ Ref. 6166
cm Ø 10 x 4

B

N



⇒ Ref. 6526
cm 11 x 10 x 5,5

B



⇒ Ref. 6531
cm 16 x 13 x 4



Ref. 6570
cm 29 x 23 x 10,5

B



CORAZÓN DE MARÍA

Ref. 6008
cm 36 x 12 x 8

B A
N



CORAZÓN DE MARÍA

Ref. 6111
cm 37 x 31 x 4



CORAZÓN DE MARÍA

Ref. 6380
cm 29 x 23 x 3

B



CORAZÓN DE MARÍA

Ref. 6006
cm 38 x 26 x 7

B

N



VIRGEN NIÑA

⇒ Ref. 6422
cm 46 x 24 x 3

B



NIÑA MARÍA

⇒ Ref. 6356
cm 24 x 11 x 6



⇒ Ref. 6376
cm 31 x 25 x 3



VIRGEN NIÑA

⇒ Ref. 6350
cm 30 x 15 x 3

B



VIRGEN NIÑA

⇒ Ref. 6738
cm 27 x 17 x 9



VIRGEN NIÑA

⇒ Ref. 6004
cm 29 x 21 x 7

A

N



VIRGEN NIÑA

⇒ Ref. 6346
cm 36 x 17 x 7

B



⇒ Ref. 6509
cm 17 x 10 x 2



⇒ Ref. 6572
cm 26 x 19 x 5,5

N



SANTA ROSA

⇒ Ref. 6324
cm 37 x 13 x 7

B



SANTA RITA

⇒ Ref. 6322
cm 37 x 13 x 7

B A
N



SANTA TERESA

⇒ Ref. 6028
cm 31 x 13 x 4

B



SAN AGUSTÍN

⇒ Ref. 6395
cm 37 x 15 x 4

B



SAN ANDRÉS

⇒ Ref. 6390
cm 37 x 21 x 8

B



SAN ANTONIO

⇒ Ref. 6078
cm 38 x 13 x 9

B

A

N



SAN ANTONIO

⇒ Ref. 6058
cm 36 x 13 x 3

B

A

N



SAN ANTONIO

⇒ Ref. 6372
cm 34 x 26 x 3

B



SAN ANTONIO

⇒ Ref. 6492
cm 20 x 14 x 5

B



SAN ANTONIO ABAD

⇒ Ref. 6076
cm 37 x 18 x 8

B

N



SAN BLAS

Ref. 6318
cm 33 x 15 x 8

B



SAN CRISTÓBAL

Ref. 6394
cm 39 x 16 x 7

B



SAN ENRIQUE

Ref. 6316
cm 36 x 13 x 5



SAN FRANCISCO

Ref. 6080
cm 36 x 12 x 7

B

A

N



SAN JORGE

Ref. 6518
cm 38 x 28 x 7

N



SAN FRANCISCO

Ref. 6082
cm 37 x 22 x 6

B

N



SAN JOAQUÍN

Ref. 6328
cm 36 x 14 x 6



SAN JOSÉ

⇒ Ref. 6511
cm 43 x 12 x 6

B



SAN JOSÉ

⇒ Ref. 6052
cm 34 x 12 x 6

B



SAN JOSÉ

⇒ Ref. 6508
cm 41 x 13 x 7

B



SAN JOSÉ

⇒ Ref. 6510
cm 34 x 14 x 8

B

N



SAN JOSÉ

⇒ Ref. 6050
cm 36 x 13 x 7

B

A

N



SAN JOSÉ

⇒ Ref. 6056
cm 34 x 13 x 3

B



SAN JOSÉ

⇒ Ref. 6734
cm 22 x 14 x 5

B



SAN JOSÉ

⇒ Ref. 6054
cm 38 x 13 x 9

B



SAN JUAN

⇒ Ref. 6068
cm 38 x 14 x 9

B
N



SAN LUIS

⇒ Ref. 6070
cm 35 x 13 x 7

B



SAN MIGUEL

⇒ Ref. 6340
cm 47 x 21 x 8

N



SAN PEDRO

⇒ Ref. 6072
cm 36 x 14 x 7

B



SAN MIGUEL

⇒ Ref. 6342
cm 39 x 23 x 6

B
N



SAN RAFAEL

⇒ Ref. 6062
cm 37 x 20 x 10

B



SAN RAMÓN

⇒ Ref. 6314
cm 34 x 15 x 7



SANTO TOMÁS DE AQUINO

Ref. 6391
cm 37 x 15 x 7



SAN VICENTE

Ref. 6066
cm 37 x 17 x 8

B
N



PIEDAD

Ref. 6561
cm 49 x 28 x 9

B
N



PIEDAD

Ref. 6410
cm 47 x 37 x 8

B
N



PIEDAD

Ref. 6124
cm 33 x 32 x 5



PIEDAD

⇒ Ref. 6730
cm 55 x 37 x 9



PIEDAD

⇒ Ref. 6681
cm 12 x 11 x 3



PIEDAD

⇒ Ref. 6128
cm 34 x 33 x 6



PIEDAD

⇒ Ref. 6112
cm 50 x 33 x 7,5





PIEDAD CON ÁNGEL

Ref. 6396
cm 34 x 29 x 8

B



PIEDAD

Ref. 6476
cm 41 x 18 x 5

B A

N



PIEDAD CON ÁNGEL

Ref. 6116
cm 51 x 41 x 10



SAGRADA FAMILIA

⇒ Ref. 6144
cm 58 x 28 x 7



CINTA

⇒ Ref. 6146
cm 64 x 18 x 4



ENTIERRO

⇒ Ref. 6334
cm 60 x 41 x 9

B



ORACIÓN DEL HUERTO

∞ Ref. 6265
cm 43 x 28 x 4



CRISTO DE MEDINACELI

∞ Ref. 6640
cm 32 x 10 x 8

B
N



SAGRADA FAMILIA

∞ Ref. 6344
cm 38 x 25 x 7

B



∞ Ref. 6545
cm 33 x 22 x 3,5

B



∞ Ref. 6547
cm 33 x 22 x 3,5

B



ÁNGEL DEL SILENCIO

∞ Ref. 6044
cm 34 x 14 x 8

B



⇒ Ref. 6348
cm 58 x 30 x 6

B



ÁNGEL DE LA GUARDA

⇒ Ref. 6040
cm 38 x 21 x 11

B

A



⇒ Ref. 6339
cm 59 x 28 x 9



⇒ Ref. 6601
cm 24 x 13 x 2

B



⇒ Ref. 6599
cm 24 x 13 x 2

B



⇒ Ref. 6034
cm 37 x 12 x 3



⇒ Ref. 6036
cm 37 x 12 x 3



⇒ Ref. 6593 B
cm 14 x 7,5 x 4,5



⇒ Ref. 6358 B
cm 17 x 8 x 4



⇒ Ref. 6611 B
cm 13 x 10 x 5



⇒ Ref. 6610 B
cm 12 x 9 x 5



⇒ Ref. 6605 B
cm 11 x 10 x 2



⇒ Ref. 6603 B
cm 11 x 10 x 2



⇒ Ref. 6362 B
cm 19 x 15 x 6



NIÑO CON PALOMA

⇒ Ref. 6352
cm 32 x 13 x 3



⇒ Ref. 6609 B
cm 10,5 x 5,5 x 3



⇒ Ref. 6607 B
cm 10,5 x 5,5 x 3



⇒ Ref. 6360
cm 21 x 15 x 4



⇒ Ref. 6428 B
cm 27 x 16 x 6



⇒ Ref. 6541
cm 20 x 10,5 x 3,5



⇒ Ref. 6540
cm 20 x 10,5 x 3,5



⇒ Ref. 6507
cm 17 x 11 x 4



⇒ Ref. 6505
cm 17 x 9 x 4



⇒ Ref. 6986
cm 12 x 11 x 1

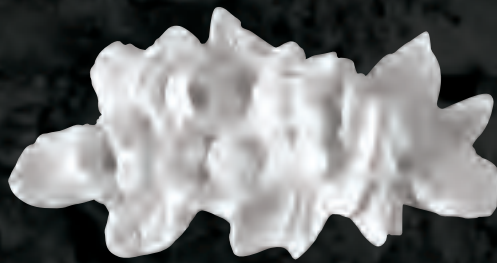

⇒ Ref. 6202
cm 16 x 8 x 4

N

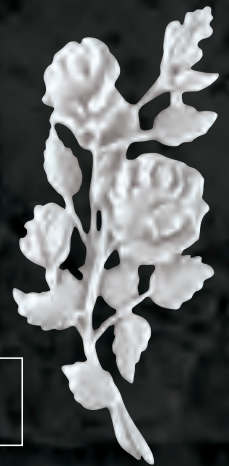

⇒ Ref. 6984
cm 18 x 8 x 2



⇒ Ref. 6979
cm 9 x 9 x 1

B



⇒ Ref. 6987
cm 12,5 x 13 x 2

B



⇒ Ref. 6918
cm 20 x 11 x 1



⇒ Ref. 6919
cm 15 x 12 x 1,5



⇒ Ref. 6901
cm 10,5 x 7,5 x 1,5



⇒ Ref. 6705
25 x 10 x 4,5

B

A



⇒ Ref. 6982
cm 8 x 6 x 2

B



⇒ Ref. 6983
cm 13 x 8 x 1

B



⇒ Ref. 6242
cm 75 x 14 x 2



⇒ Ref. 6402
cm 66 x 17 x 2



⇒ Ref. 6625
cm 46 x 13 x 5



⇒ Ref. 6440
cm Ø10 x 2,5



⇒ Ref. 6438
cm 5 x 5 x 2

N



⇒ Ref. 6290
cm 3 x 2,5 x 1

⇒ Ref. 6292
cm 9 x 6 x 2

⇒ Ref. 6293
cm 10 x 8 x 2

⇒ Ref. 6294
cm 11 x 8 x 3

B

B



⇒ Ref. 6291
cm 3 x 2,5 x 1



⇒ Ref. 6246
cm 40 x 5 x 4

⇒ Ref. 6247
cm 50 x 6 x 4



⇒ Ref. 6639
cm 48,5 x 8,5 x 4,5



⇒ Ref. 6274
cm 8 x 7 x 5

⇒ Ref. 6248
cm 48,5 x 4 x 3,5

⇒ Ref. 6249
cm 61 x 4 x 3



⇒ Ref. 6278
cm 8 x 6 x 5



⇒ Ref. 6543
cm 58 x 40 x 4



⇒ Ref. 6542
cm 45 x 35 x 4



⇒ Ref. 6533
cm 40 x 35,5 x 5



⇒ Ref. 6544 **B**
cm 39 x 30 x 3,5



⇒ Ref. 6535 **B**
cm 36 x 28 x 5



⇒ Ref. 6530 **B**
cm 36 x 28 x 5

Ref. 6534
"FUISTE BUEN HIJO, PADRE Y BUEN ESPOSO. DIOS EN EL CIELO TE DE EL MEJOR REPOSO"

B

Ref. 6538
"A TODOS LOS QUE ME HABEIS QUERIDO OS PIDO ORACIONES, QUE ES LA MEJOR PRUEBA DE AMOR"

Ref. 6532
"LA TRISTE FLOR DEL OLVIDO NUNCA NACERA EN TU FOSA, PORQUE DIOS SABE QUE HAS SIDO BUENA MADRE Y FIEL ESPOSA"



⇒ Ref. 6536
cm 36 x 28 x 5

⇒ Ref. 6537 **B**
cm 24 x 11





∅ Ref. 6448
cm 20 x 14 x 5
∇ D 39

B N

∅ Ref. 6488
cm 16 x 13 x 8
∇ D 25

N



∅ Ref. 6196
cm 20 x 12 x 11
∇ D 74



∅ Ref. 6200
cm 19 x 11 x 9
∇ D 25

∅ Ref. 6199
cm 19 x 11 x 11
∇ D 74



∅ Ref. 6203
cm 14 x 6
∇ D 93



∅ Ref. 6236
cm 15 x 6 x 5
∇ D 23

B
P



∅ Ref. 6175
cm 19 x 17 x 11
∇ D 31
⊗ R 31 C



∅ Ref. 6176
cm 23 x 11,5 x 9
∇ V 1



∅ Ref. 6174
cm 18 x 14 x 7
∇ D 32
⊗ R 32 C



⇒ Ref. 6191 S
cm 22,5 x 10 x 9
V 1



⇒ Ref. 6193 S
cm 11,5 x 10 x 9
V D 82



⇒ Ref. 6190 S
↔ ↕ ↘
cm 21 x 18 x 12
V D 121
⊗ R 12 C



⇒ Ref. 6504 P
cm 18 x 11 x 8,5
V D 35



⇒ Ref. 6231 P
cm 18 x 11 x 9
V D 35



⇒ Ref. 6234 P
cm 16 x 10 x 8
V D 25



⇒ Ref. 6506 P
cm 17 x 11 x 9
V D 35



⇒ Ref. 6232 P
cm 18 x 12 x 9
V D 35



⇒ Ref. 6306 P
cm 16 x 9 x 7
V D 25



∅ Ref. 6226 P
cm 40 x 9 x 12
∇ D 108



∅ Ref. 6230 P
cm 38 x 10 x 9
∇ D 108



∅ Ref. 6223 P
cm 39 x 9 x 11
∇ D 108



∅ Ref. 6502 P
cm 40 x 10 x 10
∇ D 108



∅ Ref. 6224 P
cm 48 x 12 x 10
∇ D 112





⇒ Ref. 6442 P
cm 24 x 12 x 8 B
∇ D 114



⇒ Ref. 6198 P
cm 16 x 10 x 9 B
∇ D 21



⇒ Ref. 6204 P
cm 18 x 12 x 10



⇒ Ref. 6404 P
cm 18 x 12 x 11



⇒ Ref. 6490 N
cm 9 x 14 x 7,5 B



⇒ Ref. 6304 P
cm 26 x 7,5 x 2,5

urnas

urns

urnas

urnes cinéraires

urne

urnen



URNAS DE BRONCE
URNAS DE ACERO INOXIDABLE
URNAS DE MARMOL RECONSTITUIDO

BRONZE URNS
STAINLESS STEEL URNS
CULTURED MARBLE URNS





Ref. 3625
cm 31 x 25 x 21
Capacity: 2,33 litres

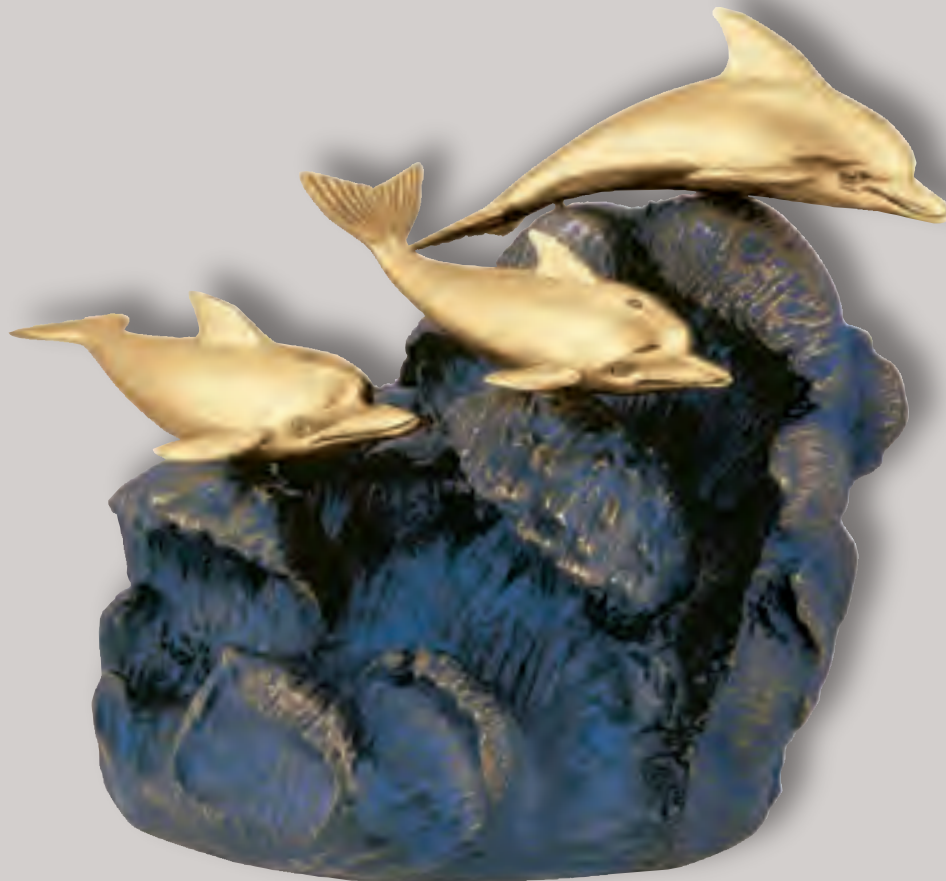

Ref. 3626
cm 31 x 25 x 21



Ref. 3627
↑ ↔ ∨
cm 50 x 34 x 26
Capacity: 2,80 litres



Ref. 3906
cm 58 x 29 x 27
Capacity: 2,25 litres



Ref. 3905
cm 45 x 17,5
Capacity: 3,77 litres



Ref. 3660
cm 27 x 15
Capacity: 2,91 litres



Ref. 3661
cm 27 x 15



Ref. 3662
cm 27 x 15



Ref. 3663
cm 27 x 15



Ref. 3632
cm 29 x 19



Ref. 3630
cm 29 x 19
Capacity: 3,71 litres



Ref. 3670
cm 27 x 15
Capacity: 2,44 litres



Ref. 3671
cm 27 x 15



Ref. 3672
cm 27 x 15



Ref. 3678
cm 27 x 15



Ref. 3673
cm 27 x 15



Ref. 3600 B
SOLO base de mármol reconstituido negro pulido.
ONLY black cultured marble base.



Ref. 3654
cm 21 x 17 x 14
Capacity: 4,65 litres



Ref. 3650
cm 21 x 17 x 14
Capacity: 4,65 litres



Ref. 3650 EJEMPLO/EXAMPLE
CON APLIQUE ADHESIVO
WITH ADHESIVE BRONZE MOTIF



Ref. 3655
cm 27,5 x 22,5 x 18
Capacity: 10,36 litres



Ref. 3640 EJEMPLO/EXAMPLE
CON APLIQUE ADHESIVO
WITH ADHESIVE BRONZE MOTIF



Ref. 3640
cm 19,5 x 14,5
Capacity: 3,08 litres

LOS PEQUEÑOS APLIQUES QUE ADMITEN BANDA ADHESIVA LLEVAN EL SÍMBOLO
LITTLE MOTIFS ADAPTED FOR ADHESIVE BAND HAVE THIS SYMBOL





Ref. 3600 EJEMPLO/ EXAMPLE
 CON APLIQUE ADHESIVO
 WITH ADHESIVE BRONZE MOTIF



 **Ref. 3600 B**
 ONLY Black cultured marble base.
 SOLO Base de mármol reconstituido negro pulido.



Ref. 3600
 cm 21 x 17 x 14
 Capacity: 4,65 litres



Ref. 3600 EJEMPLO/ EXAMPLE
 CON APLIQUE ADHESIVO
 WITH ADHESIVE BRONZE MOTIF





Ref. 3605
 cm 27,5 x 22,5 x 18
 Capacity: 10,36 litres



Ref. 3603
 cm 13 x 9 x 9
 Capacity: 0,85 litres



Ref. 3641
 
 cm 10 x 14,5
 Capacity: 1,58 litres



Ref. 3647
 cm 13 x 9 x 9
 Capacity: 0,85 litres



Ref. 3645
 cm 13 x 9 x 9
 Capacity: 0,85 litres





Ref. 3622
↓ ↔ ∇
cm 11,5 x 14 x 11



Ref. 3680
cm 2,7 x 1,2
Colgante.
Hanging.



Ref. 3690
URNA / BÚCARO
URN / VASE
cm 11 x 5,5



Ref. 3618
cm 15 x 6



Ref. 3620
↓ ↔ ∇
cm 16 x 9 x 16



Ref. 3624
↔ ↓ ∇
cm 14 x 14 x 12



Ref. 3683
cm 6,5 x 3,6



Ref. 3689
cm 6,6 x 3,5



Ref. 3685
cm 6,5 x 3,6



Ref. 3687
cm 6,5 x 3,6



Ref. 3682
cm 6,5 x 3,6



Ref. 3688
cm 6,6 x 3,5



Ref. 3684
cm 6,5 x 3,6



Ref. 3686
cm 6,5 x 3,6



Ref. 7527
↑ ↔ ∨
cm 50 x 34 x 26
Capacity: 2,80 litres



Ref. 7462
cm 50 x 26 x 17,5
Capacity: 1,5 litres



Ref. 7454
cm 42 x 35 x 15
Capacity: 1,94 litres



Ref. 7356
cm 40 x 21 x 26
Capacity: 2,5 litres



Ref. 7450
cm 26 x 24
Capacity: 5,38 litres



Ref. 7452
cm 26 x 13 x 14
Capacity: 2,98 litres



Ref. 7450 B
cm 26 x 24
Capacity: 5,38 litres



Ref. 7452 B
cm 26 x 13 x 14
Capacity: 2,98 litres

mascotas

pets

MASCOTAS - Pequeños apliques para cuya fijación es necesario utilizar pegamento o banda adhesiva.

PETS - Little articles that for their fixing must be used glue or adhesive tape.

MASCOTES - Pequenos artigos para serem fixados é necessário o uso de cola ou fita adesiva.



ANIMAUX DE COMPAGNIE - Petits articles que pour sa fixation il est nécessaire d'utiliser une colle ou bien une bande adhésive.

ANIMALI DOMESTICI - Piccoli articoli che per il loro fissaggio è necessario utilizzare colla o nastro biadesivo.

LIEVELINGSDIJREN - Om kleine artikelen te bevestigen moet men gebruik maken van dubbelzijdige kleefband of lijm.





Ref. 1520
cm 5 x 4 x 0,5



Ref. 1521
cm 5 x 4 x 0,5



Ref. 1522
cm 5 x 4 x 0,5



Ref. 1523
cm 5 x 4 x 0,5



Ref. 1524
cm 5 x 4 x 0,5



Ref. 1525
cm 5 x 4 x 0,5



Ref. 1526
cm 5 x 4 x 0,5



Ref. 1527
cm 5 x 4 x 0,5



Ref. 1528
cm 5 x 4 x 0,5



Ref. 1529
cm 5 x 4 x 0,5



Ref. 1530
cm 5 x 4 x 0,5



Ref. 1531
cm 5 x 4 x 0,5



Ref. 1532
cm 5 x 4 x 0,5



Ref. 1533
cm 5 x 4 x 0,5



Ref. 1534
cm 5 x 4 x 0,5



Ref. 1535
cm 5 x 4 x 0,5



Ref. 1536
cm 5 x 4 x 0,5



Ref. 1537
cm 5 x 4 x 0,5



Ref. 1538
cm 5 x 4 x 0,5



Ref. 1539
cm 5 x 4 x 0,5



Ref. 6988 B
cm 9 x 6,7 x 1



Ref. 6990 B
cm 9 x 6,4 x 0,5



Ref. 6980
cm 6 x 2,5 x 1

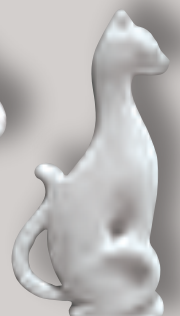

Ref. 6981
cm 9,5 x 3,5 x 1



Ref. 6989 B
cm 9 x 6,4 x 0,5



Ref. 6985 B
cm 10 x 5,5 x 1



Ref. 6992 B
cm 9 x 6 x 1



Ref. 6991 B
cm 9 x 6 x 1

accesorios

accessories

ELEMENTOS ESENCIALES

En esta sección, se muestran una serie de elementos de fabricación propia que se incluyen, sin necesidad de solicitarlo, cuando la fijación o correcto funcionamiento de cualquiera de nuestros artículos lo precisa. Además estos artículos se suministran de forma independiente ya que pueden destinarse a otras funciones.

Junto a esta serie de artículos también aparecen productos que son utilizados habitualmente por nuestros clientes, pero aunque no han sido producidos por Bronces Jordá, los hemos seleccionado entre los mejores proveedores para poder ofrecerles un mejor servicio.

ELEMENTOS ESSENCIAIS

Nesta secção apresenta-se uma série de elementos de fabricação própria que se incluem, sem a necessidade de solicitá-los, quando precisos na fixação ou no correcto funcionamento de qualquer um dos nossos artigos.

Além disso, estes artigos são fornecidos de forma independente, já que podem destinar-se a outras funções.

Junto com esta série de artigos, também aparecem produtos que são utilizados habitualmente pelos nossos clientes, mesmo que não tenham sido produzidos pela Bronces Jordá, seleccionamo-los entre os melhores fornecedores para poder oferecer-lhes o melhor serviço.

ESSENTIAL ITEMS

This section displays a number of self-produced items that are automatically included when the placement or correct operation of any of our articles so requires. No special request is necessary. In addition, these items are available independently and can be directed to other uses.

These articles appear along with products that are regularly used by our customers. Although they are not manufactured by Bronces Jordá, we have selected them from the finest suppliers in order to offer the best possible service to our customers.

ELÉMENTS ESSENTIELS

Dans cette section, vous trouverez toute une série d'éléments de fabrication propre, qui sont compris lorsque l'assemblage ou le bon fonctionnement de n'importe lequel de nos articles le requiert, et ceci sans qu'il soit nécessaire d'en faire la demande. De plus, ces articles sont livrés séparément car ils peuvent être destinés à d'autres usages.

A cette série d'articles s'ajoutent aussi des produits fréquemment utilisés par nos clients. Bien qu'ils ne soient pas fabriqués chez Bronces Jordá, nous les avons sélectionnés chez les meilleurs fournisseurs afin de vous garantir un excellent service.

ELEMENTI ESSENZIALI

In questa sezione c'è una serie di elementi di fabbricazione propria che sono inclusi, senza alcuna richiesta previa, quando il fissaggio od il corretto funzionamento di qualunque dei nostri articoli ne richieda l'uso. Questi articoli inoltre, vengono anche forniti in maniera indipendente per una loro applicazione a funzioni diverse.

Insieme a questa serie di articoli ci sono anche prodotti che di solito vengono utilizzati dai nostri clienti, e benché non siano stati prodotti da Bronces Jordá, li abbiamo selezionati tra i migliori fornitori del settore per poter offrire un ottimo servizio.

ESSENTIËLE ELEMENTEN

In deze sectie tonen wij u een serie elementen van eigen fabrikaat die automatisch meegeleverd worden indien de bevestiging of het juiste functioneren van onze artikelen dit vereist. Deze artikelen zijn ook apart verkrijgbaar aangezien ze ook voor andere doeleinden gebruikt kunnen worden.

Naast deze serie artikelen treft u een aantal andere veelgevraagde producten aan die niet van eigen fabrikaat zijn maar een selectie vormen van producten van onze beste leveranciers waarmee we onze klanten beter van dienst hopen te kunnen zijn.





CETRO MARIA AUXILIADORA

Ref. 5508 9 cm
Ref. 5508C 9 cm



POTENCIAS

Ref. 5510 cm 9,5 X 5,5
Ref. 5510C cm 9,5 X 5,5



VARA SAN JOSÉ

Ref. 5550 24 cm
Ref. 5550C 24 cm

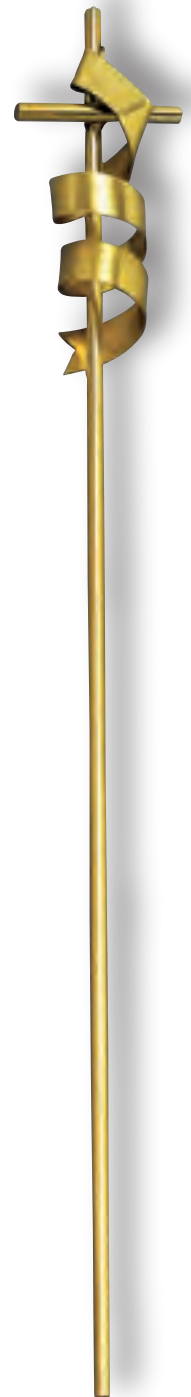

VARA SAN JUAN

Ref. 5561 32 cm
Ref. 5551 32 cm INOX

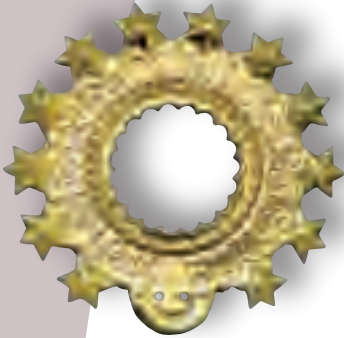

AUREOLA VIRGEN DEL CARMEN

Ref. 5502 Ø 12,5 cm
Ref. 5502C Ø 12,5 cm

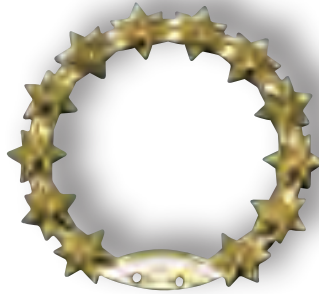

AUREOLA VIRGEN PURISIMA

Ref. 5504 Ø 10 cm
Ref. 5504C Ø 10 cm

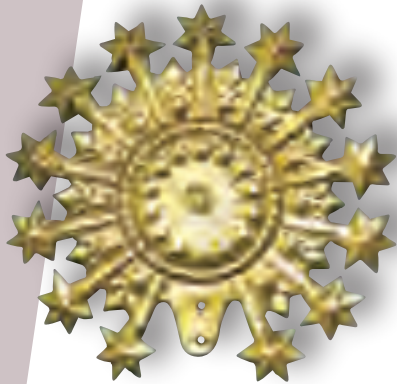

AUREOLA VIRGEN DESAMPARADOS

Ref. 5501 Ø 13 cm
Ref. 5501C Ø 13 cm



AUREOLA VIRGEN DEL PILAR

Ref. 5503 Ø 15 cm
Ref. 5503C Ø 15 cm



AUREOLA CORAZÓN DE JESÚS

Ref. 5500 Ø 10 cm
Ref. 5500C Ø 10 cm



AUREOLA SAN JOSÉ

Ref. 5505 Ø 10 cm
Ref. 5505C Ø 10 cm



AUREOLA SAN ANTONIO

Ref. 5506M Ø 10 cm
Ref. 5506 Ø 10 cm INOX



Ref. 5507 Ø 10 cm



Ref. LS3
cm 15,5 x 6,5

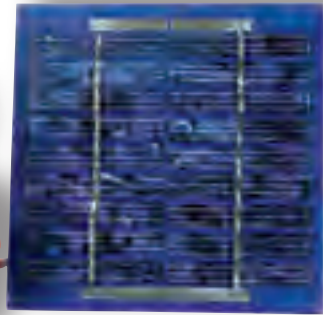

Ref. PS1
cm 12,7 x 12,7 x 0,3
⚡ 100 MA



Ref. LS1
cm 13 x 7,5

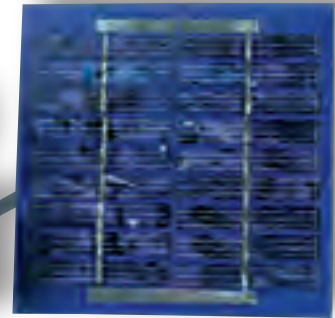

Ref. PS1
cm 12,7 x 12,7 x 0,3
⚡ 100 MA

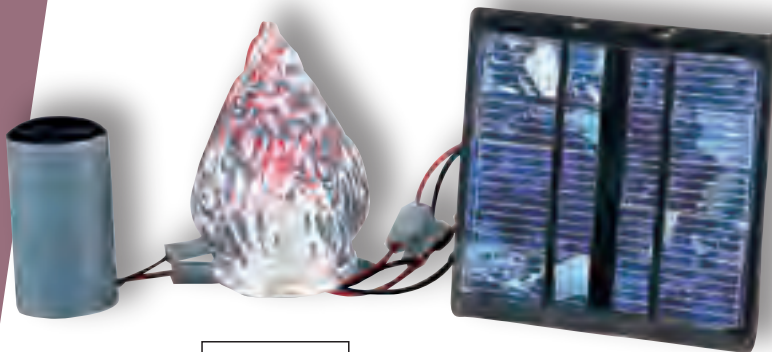

Ref. LS2

Ref. PS2
cm 9,5 x 9,5 x 0,3
⚡ 90 MA

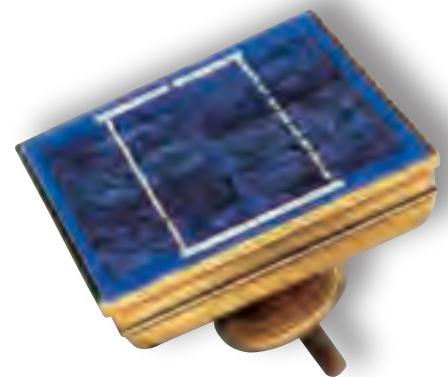

Ref. PS6
cm 12,3 x 12,3 x 7,5



Ref. LE1
cm 7,5 x 6,5
Lámpara luz eléctrica
con cargador



Ref. LE2
cm 7,5 x 6,5
Lámpara luz eléctrica
sin cargador



Ref. PS5
cm 13 x 13 x 7,5



Ref. LM207CR
cm 12 x 6
💡 (1 BAT  9 V)



Ref. LM222CR
cm 16 x 6
💡 (2 BAT  1,5 V)



Ref. LP1
cm 11 x 4
💡 (4 BAT  1,5 V)



Ref. CLI3
cm 9 x 4,5
Luz para 90 días
No recargable
90 days light
Not rechargeable
En cajas de 5 unidades
5 units box



Ref. LM410R
cm 10 x 6,5
Ref. LM410B
cm 10 x 6,5
Plástico y luz blanca
White plastic and light
Ref. LI3
cm 13,5 x 6,5
Luz para 1 año
No recargable
One year light
Not rechargeable



Ref. LP4
cm 16 x 7
💡 (2 BAT  1,5 V)



Ref. LP5
cm 13,5 x 7
💡 (2 BAT  1,5 V)



Ref. LP6
cm 9 x 7
💡 (1 BAT  9 V)



Ref. LI2
Ref. LI2F
cm 12,5 x 7,5
No recargable
Not rechargeable



Ref. LP8
cm 10 x 4
💡 (2 BAT  1,5 V)



Ref. LI1
cm 10 x 2,5
Luz para 1 año
No recargable
One year light
Not rechargeable

F: sistema FLASH SYSTEM
POTENTE DESTELLO LUMINOSO
POWERFUL WINKING LIGHT



Ref. LP2
Ref. LP2F
cm 9 x 6,5
💡 (1 BAT  1,5 V)



Ref. 4010 1,2 x 8 x 1,5 cm
 Ref. 4011 1,2 x 6 x 1,2 cm
 ● INOX Ø 2,5 mm

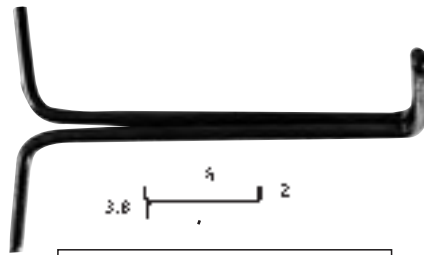

Ref. 4015 3,8 x 8 x 2 cm
 Ref. 4016 3,8 x 6 x 2 cm
 ● INOX Ø 2,5 mm

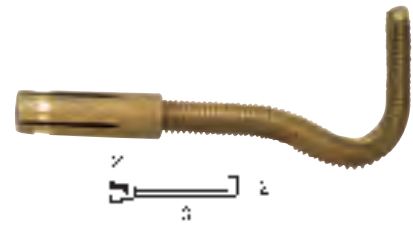

Ref. 4042 A
 2 x 3 x 2 cm
 Ø 6 mm



TACO 5 M5
 TACO 8 M8

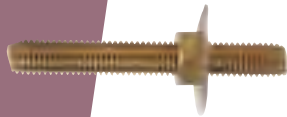

LATÓN / BRASS

	Ø 3 mm	Ø 4 mm	Ø 5 mm	Ø 6 mm	Ø 8 mm
ESPARRAGOS	Ref.	Ref.	Ref.	Ref.	Ref.
↔ 45 mm	E345	E445	E545	E645	-
↔ 60 mm	-	E460	E560	E660	E860
↔ 70 mm	-	E470	-	E670	-
↔ 80 mm	-	E480	E580	E680	E890
↔ 100 mm	-	E4100	-	-	-
TUERCAS	TM3	TM4	TM5	TM6	TM8
ARANDELAS	AM3	AM4	AM5	AM6	AM8
VARILLAS	Ref.	Ref.	Ref.	Ref.	Ref.
↔ 50 cm	-	V450	V550	V650	-
↔ 100 cm	V3100	V4100	V5100	V6100	V8100

INOXIDABLE

LATÓN / BRASS



CON ROSCA INTERIOR

Ref. 5008
 23 X 60 mm
 LATÓN
 BRASS

Ref. 5008l
 23 X 60 mm
 Ref. 5013
 23 x 70 mm
 ACERO INOXIDABLE
 STAINLESS STEEL

Ref. 5009
 M4 X 40 mm
 Ref. 5011
 M4 x 40 mm
 NIQUELADO

Ref. 5003
 M4 X 50 mm
 LATÓN
 BRASS



TOPES CRUCES

Ref. 5006 SATINADO
 Ref. 5006 S NIQUELADO
 Ø 8 ↓ 9 mm
 Ref. 5007 SATINADO
 Ref. 5007 S NIQUELADO
 Ø 12 ↓ 12 mm



Ref. 4113 INOX.
 Ø 3 cm ∴ Ø 6 cm



TORNILLO JARDINERA

Ref. 5005
 5/32" x 12 cm
 Ø 1,8 cm



○ Ref. 4112 INOX.
 Ø 3 cm
 P.V. x cm

SERIGRAFIADAS 10 x 2 cm

○ PERPETUIDAD ○

○ PROPIEDAD ○

Ref. 7625 INOX.

▽ Ref. 7605
 CLAVOS FIJACIÓN

▽ Ref. 7621
 ALUMINIO ANONIZADO

FIRMAS • SIGNATURES • PLACAS IDENTIFICADORAS • TARGA DEL MARMISTA • MANUFACTURER'S PLATE

INOX.
 Ref. 7600* 7601*
 Cantidad 100 250
 Ref. 7627 (CLICHE)



ALUMINIO ANODIZADO
 Ref. 7610* 7611*
 Cantidad 250 500

*CONSULTEN PRECIO Y PLAZO DE ENTREGA / *ASK FOR PRICE AND DELIVERY TIME

CINCEL

Ref. MANUAL	Ref. COMPRESOR	m/m ↔
8050	8050C	4
8051	8051C	6
8052	8052C	8
8053	8053C	10
8054	8054C	13
	8056C	16
	8057C	18



GRADINA

Ref. MANUAL	Ref. COMPRESOR	m/m ↔
8026	8026C	13
	8028C	18



PUNTERO

Ref. 8040	8 mm
Ref. 8041	10 mm
Ref. 8042	12 mm

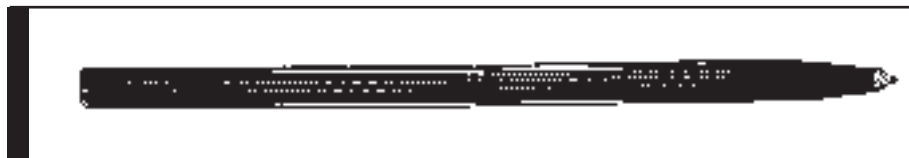

RAYADOR

Ref. 8038	6 mm
-----------	------



Ref. 8218
SPRAY PROTECTOR DEL BRONCE
 BRONZE PROTECTIVE SPRAY

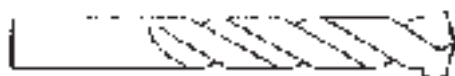

BROCAS PARA TALADRO PERCUTOR

Referencia	Ø
8070	3 mm
8071	3,5 mm
8072	4 mm
8073	5 mm
8074	6 mm
8075	7 mm
8076	8 mm
8078	10 mm
8079	12 mm



BARRENA DE PANTOGRAFO

Ref. 8091



Ref. 8160 1 Kg

PEGAMENTO LIQUIDO
 LIQUID GLUE



Ref. 8163 1,5 Kg
 Ref. 8164 6 Kg

MASILLA NEUTRA
 NEUTRAL PUTTY



≡ Ref. 2200
cm 45 x 20 Ø 2,7
≡ Ref. 2199
cm 45 x 20 Ø 4

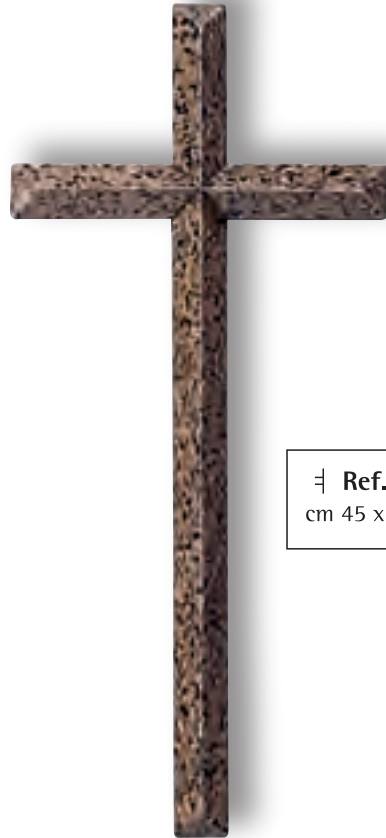

≡ Ref. 2203
cm 45 x 20 x 2,7



≡ Ref. 2198 cm 19 x 12 x 6
∨ D 2198



≡ Ref. 2291 cm 30 x 11 x 6
∨ D 2291D



≡ Ref. 2192 cm 18 x 12 x 6
∨ D 2198
≡ Ref. 2193 cm 18 x 12 x 9
∨ D 2193



≡ Ref. 2196 cm 16 Ø 8,5 cm
∨ D 2197



≡ Ref. 2197 cm 17 Ø 10 cm
∨ D 2197



○ Ref. 2195 cm 22 x 15 x 15
○ Ref. 2194 cm 27 x 15 x 15
∨ D 2194

Indiquen qué tipo de granito precisan - Specify type of granite required - Indiquem que tipo de granito pretendem
Indiquez le type de granite nécessaire - Indicare di che tipo de granito hanno bisogno - Duid de gewenste Granietsoort aan

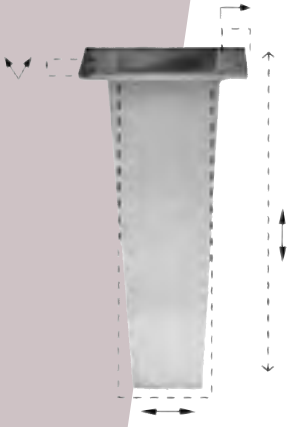

Ref.	↑↓	↔	↘	↗
D7	144	46	51	10



Ref.	↑↓	↔	↘	↗	⊗
D10	135	110	60	5	R10
D12	155	130	60	5	



Ref.	↑↓	↔	↘	↗
D2	120	80	53	5
D4	165	80	53	5



Ref.	↑↓	↔	↘	↗	⊗
D21	80	110	60	8	
D23	122	32	35	5	
D25	128	60	52	7	
D27	132	95	60	10	
D31	146	107	70	5	R31
D32	148	97	47	6	R32
D33	155	57	60	6	
D35	155	70	66	10	
D39	152	83	35	7	
D40	157	80	53	-	

Ref.	↑↓	↔	↘	↗
D18	142	87	42	6

Ref.	↑↓	↔	↘	↗
D15	160	100	58	4



ACERO INOX. AISI-304

Ref.	↔	↑↓	↘
D252	300	70	60
D250	360	90	70

Rejilla ⊗ y pestaña ↗ pulidas/polished



Ref.	↑↓	↔	↘	↗
D49	74	100	70	10

Ref.	↑↓	↔	↗
D140	130	120	-
D145	230	105	5

Ref.	↑↓	↔	↘	↗	⊗
D42	87	180	58	8	R42 INOX.
D44	98	280	58	5	R44 INOX.
D46	60	385	40	10	



Ref.	↑↓	↔	↗
D52	97	44	5
D54	115	34	2
D56	120	44	3
D68	145	70	-
D58	147	73	7



Ref.	↑↓	↔	↗	⊗
D59	160	73	-	R59
D60	171	71	5	R60
D64	155	85	-	R64
D69	205	125	8	R69



Ref.	↑↓	↔	⊗ INOX.
D82	80	48	5
D84	100	90	10
D86	146	90	10
D88	206	150	10



Ref.	↑↓	↔	↗
D71	118	60	2
D73	140	82	8
D74	150	75	0,3
D75	150	97	17
D77	162	73	9
D79	200	118	10



Ref.	↑↓	↔	↗	⊗
D91	95	32	3	
D93	104	42	6	
D96	120	65	-	R96
D97	167	70	5	R97



Ref.	↑↓	↔	↗
D100	160	76	5



Ref.	↑↓	↔	↗
D103	157	58	3



Ref.	↑↓	↔	↘	↗	⊗
D51	102	295	60	5	R51 INOX. R51M BRONCE



Ref.	↑↓	↔	↘	↗	⊗
D108	70	325	70	12	
D112	77	410	72	10	
D114	82	210	55	3	R114
D116	93	175	78	2	R116
D118	95	352	80	3	R118
D120	95	124	62	3	R120
D122	115	217	60	3	R122
D123	115	207	57	8	R123
D124	120	215	55	3	R124 INOX. R124M BRONCE



Ref.	↑↓	↔
D200	155	103
D202	160	94

condiciones generales de venta

1. Todas las ventas se efectuarán de acuerdo con las siguientes condiciones, que el comprador acepta en todas sus partes, salvo modificaciones efectuadas por escrito y de común acuerdo.
2. La mercancía viaja siempre por cuenta y riesgo del comprador, no haciéndose cargo esta empresa de las roturas o pérdidas de mercancía. El receptor deberá formular reclamación a la empresa de transporte.
3. Los precios de tarifa no están incrementados con el impuesto sobre el valor añadido (IVA). Éste se aplicará según la normativa comunitaria y, en su caso, con los porcentajes establecidos en cada país.
4. Los precios de tarifa están sujetos a modificaciones que se produzcan por disposiciones legales sobre mano de obra, materias primas, energía, impuestos, alteraciones en el cambio oficial de la moneda, etc.
5. Los precios de aquellos artículos que comercializados por la empresa, no son de su propia fabricación (pág. 308, 309, serigrafiados en pág. 310, 311 y 312), podrán variarse sin necesidad de editar una nueva tarifa, la variación responderá siempre a los incrementos o descensos que se produzcan en origen.
6. Los precios se refieren a materiales puestos sobre camión en nuestra fábrica o almacenes, no estando incluido en los mismos los embalajes o gastos de transporte.
7. El justo criterio sobre el buen acabado de un trabajo, será sometido en caso de duda, al informe técnico de dos profesionales del ramo establecidos en la ciudad y designados por BRONCES JORDÁ, S.L.
8. Los plazos de entrega para artículos de fabricación especial que no señalen fecha exacta, se entenderán aproximados y a contar siempre desde la aceptación del precio. BRONCES JORDÁ, S.L. queda desligada de toda responsabilidad por retraso en el suministro en caso de huelgas, demoras en el transporte, falta de datos necesarios para la ejecución, fuerza mayor, etc.
9. No se aceptará ninguna devolución de mercancía que no haya sido previamente autorizada.
10. El hecho de formularnos encargos verbales o por escrito, es aceptación expresa y total de estas condiciones de venta, debiendo ser pagado el importe de nuestras facturas en nuestro domicilio, entendiéndose que el hecho de girar letras de cambio con cargo a nuestros clientes no implica renuncia por nuestra parte a esta cláusula, quedando sujeto el comprador caso de litigio a los tribunales de esta jurisdicción.

ADVERTENCIA: Todos los diseños, modelos y matrices son propiedad exclusiva de BRONCES JORDÁ, S.L. y están protegidos por patentes y por las normativas que tutelan la propiedad intelectual y los derechos de autor. Cualquier reproducción, total o parcial, está absolutamente prohibida.

BRONCES JORDÁ, S.L.

QUEDA PROHIBIDA LA VENTA DE ESTE CATÁLOGO.

ENG General Sales Terms:

1. All sales carried out in accordance with the following terms which the buyer accepts in their entirety, except for any modifications which are mutually agreed to in writing.
2. Goods are always sent on the account of and at the risk of the buyer. This company does not accept any responsibility for breakages or losses of goods, in which case the receiver should file a claim against to the forwarding company.
3. The price tariff is indicated without value added tax (V.A.T.). This tax will be applied in accordance with EU regulations, the percentages being those established in each country.
4. The price tariff is subject to modifications which may arise due to legal provisions concerning labour, raw materials, energy, taxes, alterations in the official exchange rate, etc.
5. The prices of those articles which are commercialized by the company but not manufactured by it (pages 308, 309, silk-screen printing on page 310, 311 and 312) may be varied without the need to publish a new price tariff. Said variation will always be in response to increases or decreases which occur in the price at origin.
6. Prices refer to materials loaded on trucks at our factory or warehouses and do not include packing or transport costs.
7. A fair opinion as to a job's correct finish, in the event of any doubt, will be sought by means of a technical report by two professionals of the sector established in the city and appointed by BRONCES JORDÁ, S.L.
8. Delivery times for specially manufactured articles which do not indicate exact dates will be understood to be approximate and will always run from the date which the price is accepted. BRONCES JORDÁ, S.L. cannot be held responsible in the event of any delay in supplies due to strikes, delays in transport, lack of information required to carry out orders, force majeure, etc.
9. Returns of goods which have not previously been authorized will not be accepted.
10. Orders placed verbally or in writing imply express and total acceptance of all of these sales terms. Our invoice amounts should be paid at our address, it being understood that bills of exchange which are drawn on our customers do not imply our renunciation of this clause and the buyer is subject, in the event of legal action, to the courts of this jurisdiction.

IMPORTANT NOTE: All of the designs, models and dies are the exclusive property of BRONCES JORDÁ, S.L. and are protected by patents and by the legal provisions concerning intellectual property and copyright. Any reproductions, either total or partial, are absolutely prohibited.

BRONCES JORDÁ, S.L.

FORBIDDEN TO SALE THE CATALOGUE.

PT Condições gerais de venda

1. Todas as vendas efectuar-se-ão de acordo com as seguintes condições, que o comprador aceita na sua totalidade, salvo modificações efectuadas por escrito e de comun acordo.
2. A mercadoria viaja sempre por conta e risco do comprador não ficando a cargo desta empresa os danos por quebra, extravio ou outros inerentes ao transporte. Deverá o destinatário efectuar a reclamação à empresa transportadora.
3. Os preços de tabela estão sujeitos à taxa do imposto de valor acrescentado (IVA). Este aplicar-se-á segundo a norma comunitária e, em cada caso, com as percentagens estabelecidas em cada país.
4. Os preços de tabela estão sujeitos a modificações que se produzem por disposições legais sobre mão de obra, matérias primas, energia, impostos, alterações no cambio oficial da moeda, etc.
5. Os preços dos artigos que são comercializados pela empresa e que não são de seu próprio fabrico, (pág. 308, 309 serigrafias em página 310, 311 e 312), poderão variar sem necessidade de editar nova tabela. A variação corresponderá sempre aos aumentos e descidas que se produzam na origem.
6. Não estão incluídos nos preços das mercadorias os custos de embalagem e de transporte.
7. O critério sobre a qualidade de um trabalho, será submetido em caso de dúvida, ao cuidado de 2 técnicos profissionais do ramo, estabelecidos na cidade e designados por BRONCES JORDÁ, S.L.
8. O prazo de entrega dos artigos de fábrica especial que não possuam data exata de entrega, entender-se-á aproximado e a contar com a aceitação do preço. BRONCES JORDÁ, S.L. fica excluído de toda e qualquer responsabilidade por atrasos devido a greves, demoras no transporte, falta de dados necessários para a sua execução, força de maior, etc.
9. Não se aceitará nenhuma devolução de mercadoria que não tenha sido previamente autorizada.
10. Sempre que sejam aceites encomendas verbais ou escritas presume-se a aceitação total destas condições de venda devendo ser paga a importância das nossas facturas no nosso domicílio. O facto de serem aceites letras com despesas por conta dos nossos clientes não implica renuncia pela nossa parte a esta cláusula, ficando o comprador sujeito em caso de litígio, aos tribunais desta Comarca.

ADVERTÊNCIA: Todos os desenhos, modelos e matrizes são de exclusiva propriedade de BRONCES JORDÁ, S.L. e estão protegidos por patentes e normas que tutelam a propriedade intelectual e os direitos de autor. Qualquer reprodução, total ou parcial, está absolutamente proibida.

BRONCES JORDÁ, S.L.

A VENDA DESTA CATÁLOGO É PROIBIDA

F Condition Generales de Vente:

1. Toutes les ventes s'effectuent en accord avec les conditions suivantes que l'acheteur accepte en toute part, sauf modification effectuée par écrit et d'un commun accord.
2. La marchandise voyage toujours au compte et risque de l'acheteur. Notre entreprise ne se chargera pas des dégâts ou perte des marchandises, dans ce cas là, le récepteur devra formuler réclamation à l'entreprise transportatrice.
3. Les tarifs ne sont pas augmentés avec l'impôt de la (TVA), celui-ci s'appliquera selon la normative de la C.E.E. communautaire, et ce, avec les pourcentages établis dans chaque pays.
4. Les prix de tarifs seront sujet à des modifications qui sont produites par des dispositions légales sur la main d'oeuvre, matière première, énergie, impôts, altercation dans le change de la monnaie etc.
5. Les prix de certains articles que nous commercialisons dans l'entreprise qui n'étant pas de sa propre fabrication (page. 308, 309, 310, 311 et 312), ils pourront varier sans nécessité d'éditer un nouveau tarif, la variation répondra toujours aux augmentations ou diminutions qui pourront se produire à l'origine.
6. Les prix sont rapportés aux matériaux posés sur camion dans l'entreprise et fabrique. N'étant pas compris dans ceux-ci les frais d'emballages et de transport.
7. Le juste critère sur la bonne finition du travail, en cas de doute, le résultat sera soumis par deux techniciens professionnels établis dans la ville et désignés par BRONCES JORDÁ, S.L.
8. Les délais de livraison pour des articles de fabrication spéciale ne signalent pas de date exacte, il sera entendu approximativement et à compter toujours avec l'acceptation du prix. BRONCES JORDÁ, S.L. dégage toute responsabilité pour le retard des livraisons; en cas de grèves, retard dans le transport manque de date nécessaire pour l'exécution, force majeure, etc.
9. Ne sera pas accepté aucun retour de marchandise que n'aura pas été préalablement autorisé.
10. Le fait de prendre les commandes verbales ou par écrit, exprime l'acceptation totale des conditions de vente. Le montant de nos factures devra être payé en notre domicile, entendût que, le fait de tirer des lettres de change à charge de nos clients n'implique pas le renoncement de notre part à cette clause, restant l'acheteur sujet, en cas de litige, aux tribunaux de cette juridiction.

AVERTISSEMENT: Tous les dessins, modèles et maquettes sont de propriété exclusive de BRONCES JORDÁ, S.L. et sont protégés par patente et par les normes qui protègent la propriété intellectuelle et le droit d'auteur, quelque reproduction totale ou partielle est absolument interdite.

BRONCES JORDÁ, S.L.

INTERDITE LA VENTE DE CE CATALOGUE.

I Condizioni Generali di Vendita:

1. Tutte le vendite saranno effettuate e d'accordo con le seguenti condizioni, che l'acquirente accetta in tutte le sue parti, salvo modifiche effettuate per iscritto e di comune accordo.
2. La merce viaggia sempre a carico e rischio dell'acquirente, non facendosi carico questa ditta delle rotture o perdite della merce. Il ricevente dovrà rivolgere i reclami alla ditta di trasporti.
3. I prezzi della tariffa non sono incrementati dall'Imposta sul valore aggiunto (IVA). Questo si applicherà secondo la norma comunitaria ed, in ogni caso, con le percentuali stabilite in ogni paese.
4. I prezzi della tariffa sono soggetti a modifiche che si producano per disposizioni legali relative alla mano d'opera, materie prime, energia, imposte, alterazioni nel cambio ufficiale delle valute, ecc.
5. I prezzi degli articoli che, commercializzati dalla ditta, non sono di fabbricazione propria (pag. 308, 309, 310, 311 e 312), potranno essere variati senza necessità di editare un nuovo listino prezzi, la variazione risponderà sempre agli incrementi o diminuzioni che si producano in origine.
6. I prezzi si riferiscono ai materiali caricati sul camion nella nostra fabbrica o magazzini, non essendo inclusi negli stessi gli imballaggi o spese di trasporto.
7. Il giusto criterio sul buon risultato di un lavoro, sarà sottoposto in caso di dubbio, ad una revisione tecnica da parte di due professionisti del ramo stabiliti nella città e designati da BRONCES JORDÁ, S.L.
8. Le scadenze di consegna per gli articoli di fabbricazione speciale, che non indichino una data esatta, si considereranno approssimative (alle date di consegna stabilite dalla ditta) e da contare sempre a partire dall'accettazione del prezzo. BRONCES JORDÁ, S.L. si considera libero da qualsiasi responsabilità per il ritardo nella consegna in caso di scioperi, ritardi nel trasporto, mancanza di dati necessari per la fabbricazione, casi di forza maggiore, ecc.
9. Non si accetterà nessuna restituzione di merce che non sia stata autorizzata previamente.
10. Il fatto di incaricare ordini verbali o per iscritto, è accettazione espressa e totale di queste condizioni di vendita, dovendo essere pagato l'importo delle nostre fatture presso il nostro domicilio, intendendosi che il fatto di emettere cambiali a carico dei nostri clienti non implica rinuncia da parte nostra a clausola, rimanendo soggetto l'acquirente, in caso di litigio, al Tribunale di questa giurisdizione.

AVVERTENZA: Tutti i disegni, modelli e matrici sono proprietà esclusiva di BRONCES JORDÁ, S.L., e sono protetti da brevetti e dalle norme che tutelano la proprietà intellettuale ed i diritti d'autore. Qualsiasi riproduzione, totale o parziale, è assolutamente proibita.

BRONCES JORDÁ, S.L.

LA VENDITA DE QUESTO CATALOGO E VIETATA.

NL Algemene Verkoopsvoorwaarden

1. Alle verkopen geschieden onder de volledige aanvaarding door de klant van de onderstaande verkoopsvoorwaarden, tenzij een schriftelijke wijziging in gemeen akkoord.
2. De goederen worden verstuurd op kosten en risico van de koper. Bronces JORDA is niet aansprakelijk voor schade of verlies onderweg. In dergelijke gevallen moet de koper zich wenden tot de transportfirma.
3. De opgegeven prijzen zijn steeds excl. BTW.
4. De prijzen kunnen worden herzien door o.a. wettelijke verhoging van de lonen en sociale lasten, prijsverhoging van grondstoffen en energie, koerswijzigingen, enz...
5. De prijzen van de artikelen, die niet door Bronces JORDA zelf worden vervaardigd (s. 308, 309, 310, 311 en 312), kunnen worden gewijzigd ingevolge tariefveranderingen door de respectievelijke leveranciers.
6. De opgegeven prijzen zijn af-fabriek en onverpakt. De kosten van verpakking en vervoer worden afzonderlijk op de faktuur vermeld. Onze lokale invoerders kunnen gebeurlijk met de klant een all-in prijs afspreken.
7. Ingeval van betwisting omtrent de goede afwerking wordt deze voorgelegd aan twee beroeps-techniekers door BRONCES JORDÁ aangesteld en/of aanvaard.
8. De levertijd voor speciale bestellingen is niet gebonden aan een exacte datum, en moet als vermoedelijk worden aanzien, altijd na voorafgaandelijke schriftelijke aanvaarding van de overeengekomen prijs.

BRONCES JORDÁ neemt geen aansprakelijkheid ingeval van laattijdige levering, door o.a. staking, transportmoeilijkheden, overmacht, enz...

9. Geen enkele terugzending van goederen zal worden aanvaard zonder voorafgaandelijke schriftelijke instemming.

10. Door het feit van het plaatsen van een bestelling, mondeling of schriftelijk, aanvaardt de klant onze integrale verkoopsvoorwaarden. Het bedrag van onze facturen is altijd betaalbaar in onze woonplaats. Bij het aanbieden of trekken van een wissel, zien wij daarenboven van geen enkele van onze bovengenoemde rechten af.

Alle betwistingen komen uitsluitend voor de bevoegde rechtbanken van ons eigen rechtsgebied.

WAARSCHUWING: Alle tekeningen, ontwerpen, voorbeelden en modellen blijven de uitsluitende eigendom van BRONCES JORDÁ, S.L., en zijn beschermd door patenten en octrooien, en volgens de normen van intellectuele eigendom en auteursrecht. Elke gehele of gedeeltelijke reproductie is strikt verboden, en kan tot gerechtelijke vervolging leiden.

BRONCES JORDÁ, S.L.

DEZE CATALOGUS MAG NIET WORDEN VERKOCHT.



B.I. bronces jordá



BJ bronces jordá

C/ Oliva, nº 10 - 46710 DAIMUZ (Valencia) - España

Teléfono: 96 281 93 93 - Fax: 96 281 96 05

e-mail: ventas@bronces-jorda.com
bronces-jorda@bronces-jorda.com
www.bronces-jorda.com